

General Description

The GreenMOS[®] high voltage MOSFET utilizes charge balance technology to achieve outstanding low on-resistance and lower gate charge. It is engineered to minimize conduction loss, provide superior switching performance and robust avalanche capability.

The GreenMOS[®] S series is optimized for its switching characteristics to achieve aggressive EMI standards. It is easy to use for smaller power supply systems to meet the both efficiency and EMI standards.

Features

- Low $R_{DS(ON)}$ & FOM
- Extremely low switching loss
- Excellent stability and uniformity



Applications

- LED lighting
- Charger
- Adapter
- Telecom power
- Server power
- Solar/UPS

Key Performance Parameters

Parameter	Value	Unit
$V_{DS, min} @ T_{j(max)}$	650	V
$I_D, pulse$	60	A
$R_{DS(ON), max} @ V_{GS}=10V$	0.18	Ω
Q_g	35.5	nC

Marking Information

Product Name	Package	Marking
OSG60R180HSF	TO247	OSG60R180HS

Package & Pin Information

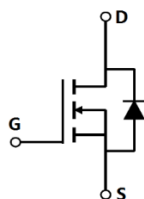

Absolute Maximum Ratings at $T_j=25^{\circ}\text{C}$ unless otherwise noted

Parameter	Symbol	Value	Unit
Drain-source voltage	V_{DS}	600	V
Gate-source voltage	V_{GS}	± 30	V
Continuous drain current ¹⁾ , $T_C=25^{\circ}\text{C}$	I_D	20	A
Continuous drain current ¹⁾ , $T_C=100^{\circ}\text{C}$		12.7	
Pulsed drain current ²⁾ , $T_C=25^{\circ}\text{C}$	$I_{D, pulse}$	60	A
Continuous diode forward current ¹⁾ , $T_C=25^{\circ}\text{C}$	I_S	20	A
Diode pulsed current ²⁾ , $T_C=25^{\circ}\text{C}$	$I_{S, pulse}$	60	A
Power dissipation ³⁾ , $T_C=25^{\circ}\text{C}$	P_D	163	W
Single pulsed avalanche energy ⁵⁾	E_{AS}	570	mJ
MOSFET dv/dt ruggedness, $V_{DS}=0\dots 480\text{ V}$	dv/dt	50	V/ns
Reverse diode dv/dt, $V_{DS}=0\dots 480\text{ V}$, $I_{SD}\leq I_D$	dv/dt	15	V/ns
Operation and storage temperature	T_{stg}, T_j	-55 to 150	$^{\circ}\text{C}$

Thermal Characteristics

Parameter	Symbol	Value	Unit
Thermal resistance, junction-case	$R_{\theta JC}$	0.77	$^{\circ}\text{C/W}$
Thermal resistance, junction-ambient ⁴⁾	$R_{\theta JA}$	62	$^{\circ}\text{C/W}$

Electrical Characteristics at $T_j=25^{\circ}\text{C}$ unless otherwise specified

Parameter	Symbol	Min.	Typ.	Max.	Unit	Test condition
Drain-source breakdown voltage	BV_{DSS}	600			V	$V_{GS}=0\text{ V}$, $I_D=250\text{ }\mu\text{A}$
		650				$V_{GS}=0\text{ V}$, $I_D=250\text{ }\mu\text{A}$, $T_j=150^{\circ}\text{C}$
Gate threshold voltage	$V_{GS(th)}$	2.9		3.9	V	$V_{DS}=V_{GS}$, $I_D=250\text{ }\mu\text{A}$
Drain-source on-state resistance	$R_{DS(on)}$		0.14	0.18	Ω	$V_{GS}=10\text{ V}$, $I_D=10\text{ A}$
			0.34			$V_{GS}=10\text{ V}$, $I_D=10\text{ A}$, $T_j=150^{\circ}\text{C}$
Gate-source leakage current	I_{GSS}			100	nA	$V_{GS}=30\text{ V}$
				-100		$V_{GS}=-30\text{ V}$
Drain-source leakage current	I_{DSS}			1	μA	$V_{DS}=600\text{ V}$, $V_{GS}=0\text{ V}$
Gate resistance	R_G		10.8		Ω	$f=1\text{ MHz}$, Open drain

Dynamic Characteristics

Parameter	Symbol	Min.	Typ.	Max.	Unit	Test condition
Input capacitance	C_{iss}		1660.9		pF	$V_{GS}=0\text{ V}$, $V_{DS}=50\text{ V}$, $f=100\text{ KHz}$
Output capacitance	C_{oss}		120.2		pF	
Reverse transfer capacitance	C_{rss}		1.3		pF	
Turn-on delay time	$t_{d(on)}$		31		ns	$V_{GS}=10\text{ V}$, $V_{DS}=400\text{ V}$, $R_G=2\ \Omega$, $I_D=10\text{ A}$
Rise time	t_r		20.1		ns	
Turn-off delay time	$t_{d(off)}$		84.4		ns	
Fall time	t_f		9.9		ns	

Gate Charge Characteristics

Parameter	Symbol	Min.	Typ.	Max.	Unit	Test condition
Total gate charge	Q_g		35.5		nC	$V_{GS}=10\text{ V}$, $V_{DS}=400\text{ V}$, $I_D=10\text{ A}$
Gate-source charge	Q_{gs}		10.3		nC	
Gate-drain charge	Q_{gd}		10		nC	
Gate plateau voltage	$V_{plateau}$		5.1		V	

Body Diode Characteristics

Parameter	Symbol	Min.	Typ.	Max.	Unit	Test condition
Diode forward voltage	V_{SD}			1.4	V	$I_S=20\text{ A}$, $V_{GS}=0\text{ V}$
Reverse recovery time	t_{rr}		364.1		ns	$V_R=400\text{ V}$, $I_S=10\text{ A}$, $di/dt=100\text{ A}/\mu\text{s}$
Reverse recovery charge	Q_{rr}		4.3		μC	
Peak reverse recovery current	I_{rrm}		26.3		A	

Note

- 1) Calculated continuous current based on maximum allowable junction temperature.
- 2) Repetitive rating; pulse width limited by max. junction temperature.
- 3) P_d is based on max. junction temperature, using junction-case thermal resistance.
- 4) The value of $R_{\theta JA}$ is measured with the device mounted on 1 in 2 FR-4 board with 2oz. Copper, in a still air environment with $T_a=25\text{ }^\circ\text{C}$.
- 5) $V_{DD}=100\text{ V}$, $V_{GS}=10\text{ V}$, $L=79.9\text{ mH}$, starting $T_j=25\text{ }^\circ\text{C}$.

Electrical Characteristics Diagrams

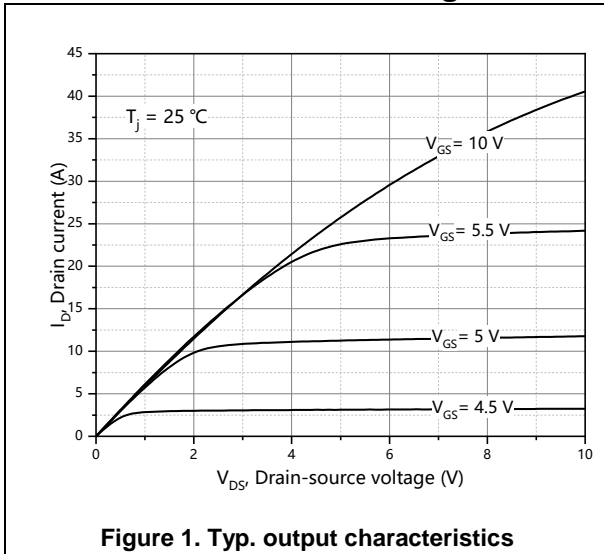

Figure 1. Typ. output characteristics

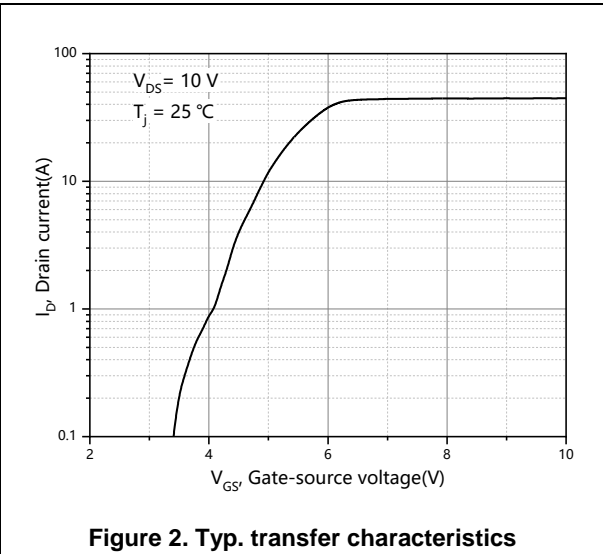

Figure 2. Typ. transfer characteristics

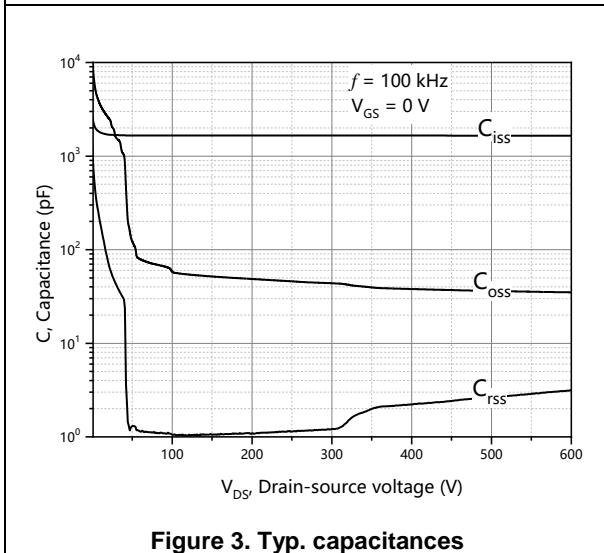

Figure 3. Typ. capacitances

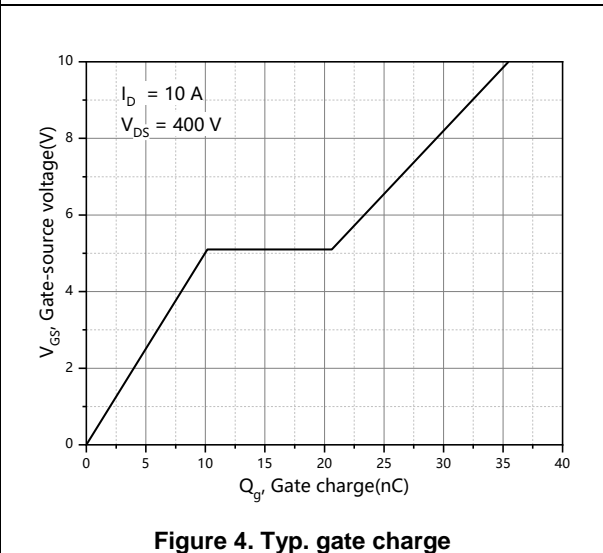

Figure 4. Typ. gate charge

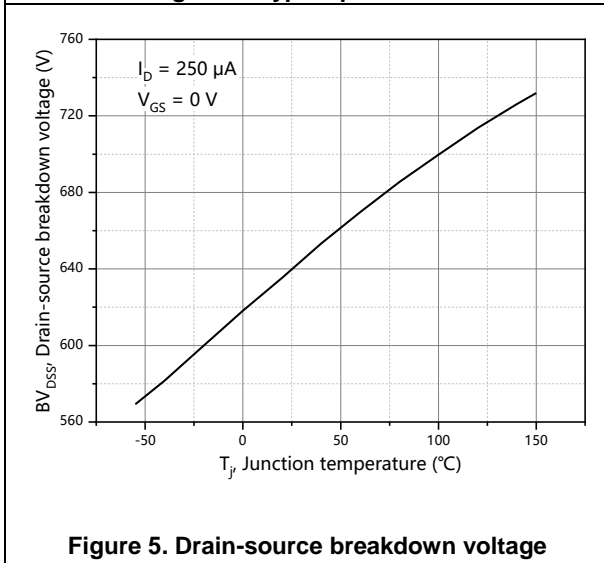

Figure 5. Drain-source breakdown voltage

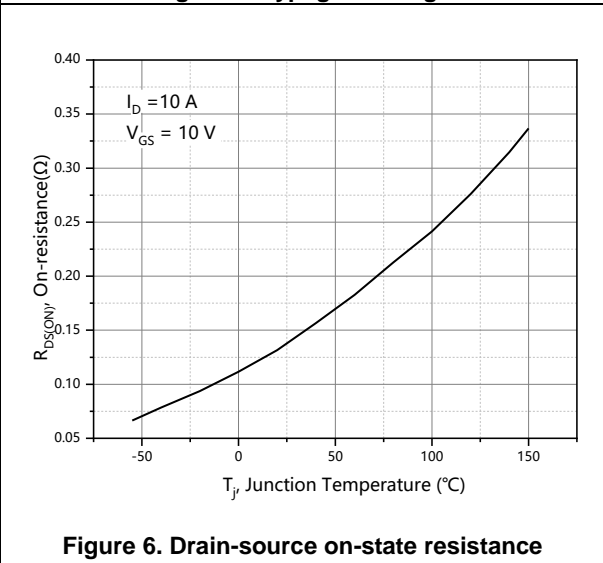
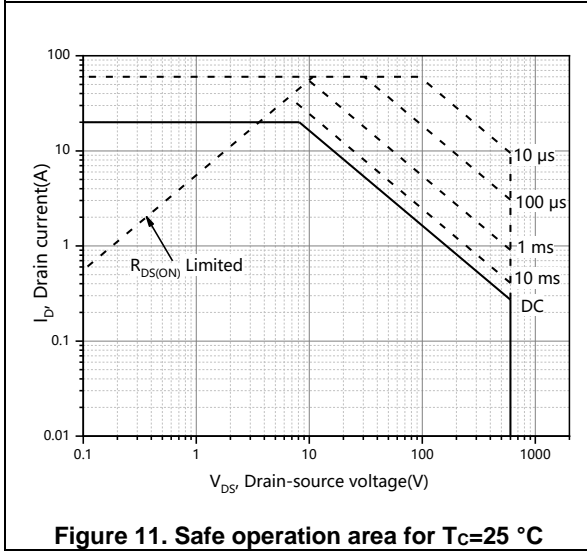
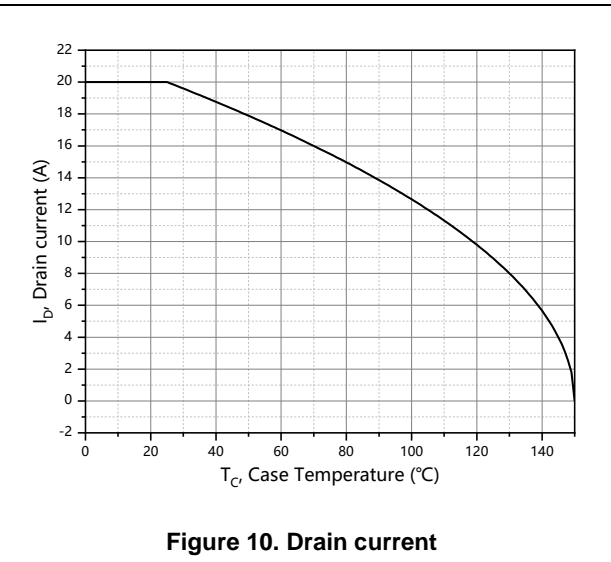
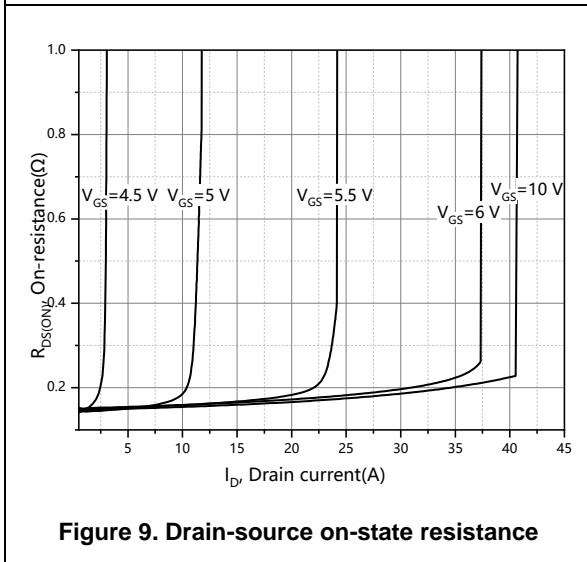
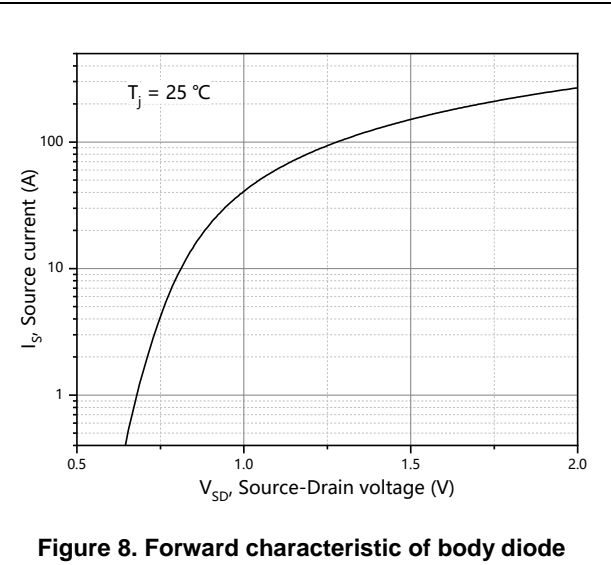
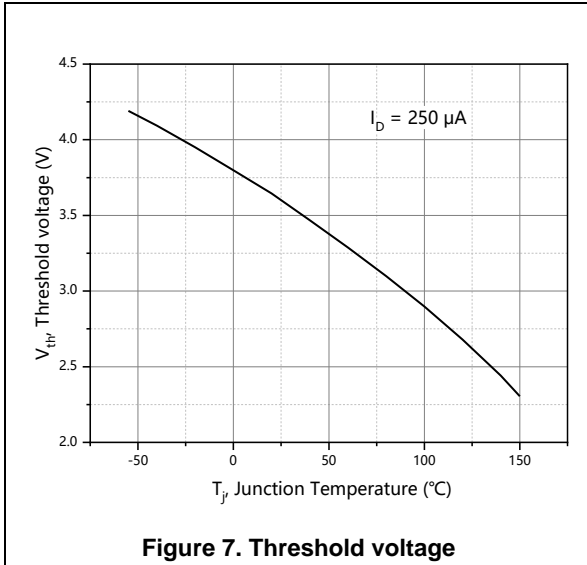

Figure 6. Drain-source on-state resistance



Test circuits and waveforms



Figure 1. Gate charge test circuit & waveform



Figure 2. Switching time test circuit & waveforms

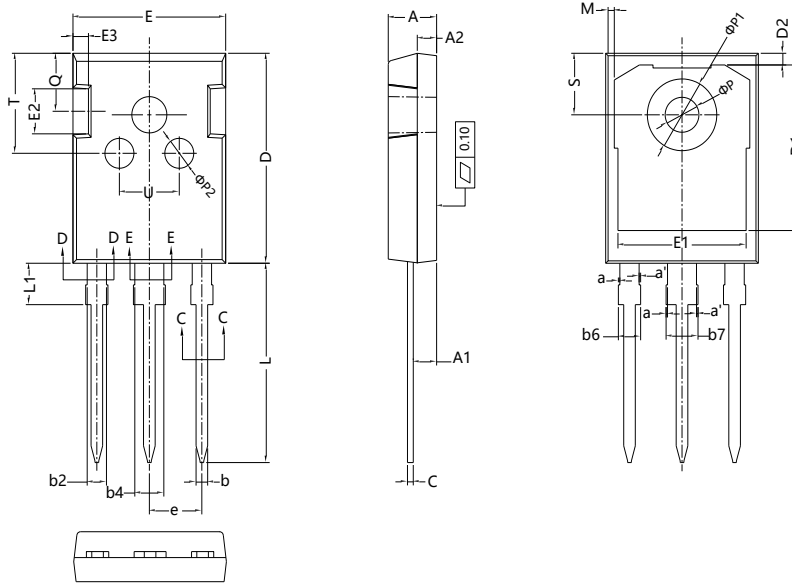

Figure 3. Unclamped inductive switching (UIS) test circuit & waveforms



Figure 4. Diode reverse recovery test circuit & waveforms

Package Information



Symbol	mm		
	Min	Nom	Max
A	4.90	5.00	5.10
A1	2.31	2.41	2.51
A2	1.90	2.00	2.10
a	0.00	-	0.15
a'	0.00	-	0.15
b	1.16	-	1.26
b2	1.96	-	2.06
b4	2.96	-	3.06
b6	-	-	2.25
b7	-	-	3.25
c	0.59	-	0.66
c1	0.58	0.60	0.62
D	20.90	21.00	21.10
D1	16.25	16.55	16.85
D2	1.05	1.17	1.35
E	15.70	15.80	15.90
E1	13.10	13.30	13.50
E2	4.40	4.50	4.60
E3	1.50	1.60	1.70
e	5.436 BSC		
L	19.80	19.92	20.10
L1	-	-	4.30
M	0.35	-	0.95
P	3.40	3.50	3.60
P1	7.00	-	7.40
P2	2.40	2.5	2.6
Q	5.60	-	6.0
S	6.05	6.15	6.25
T	9.8	-	10.20
U	6.00	-	6.40

Version 1: TO247-J package outline dimension

Ordering Information

Package Type	Units/ Tube	Tubes/ Inner Box	Units/ Inner Box	Inner Boxes/ Carton Box	Units/ Carton Box
TO247-J	30	20	600	5	3000

Product Information

Product	Package	Pb Free	RoHS	Halogen Free
OSG60R180HSF	TO247	yes	yes	yes

Legal Disclaimer

The information given in this document shall in no event be regarded as a guarantee of conditions or characteristics. With respect to any examples or hints given herein, any typical values stated herein and/or any information regarding the application of the device, Oriental Semiconductor hereby disclaims any and all warranties and liabilities of any kind, including without limitation, warranties of non-infringement of intellectual property rights of any third party.

For further information on technology, delivery terms and conditions and prices, please contact the Oriental Semiconductor sales representatives (www.orientalsemi.com).

© Oriental Semiconductor Co.,Ltd. All Rights Reserved 