

General Description

The GreenMOS[®] high voltage MOSFET utilizes charge balance technology to achieve outstanding low on-resistance and lower gate charge. It is engineered to minimize conduction loss, provide superior switching performance and robust avalanche capability.

The GreenMOS[®] Z series is integrated with fast recovery diode (FRD) to minimize reverse recovery time. It is suitable for resonant switching topologies to reach higher efficiency, higher reliability and smaller form factor.

Features

- Low $R_{DS(ON)}$ & FOM
- Extremely low switching loss
- Excellent stability and uniformity



Applications

- LED lighting
- Telecom
- Adapter
- Sever
- Solar/UPS

Key Performance Parameters

Parameter	Value	Unit
V_{DS}	650	V
$I_{D, pulse}$	150	A
$R_{DS(ON), max} @ V_{GS}=10V$	60	m Ω
Q_g	65.7	nC
PD	370	W

Marking Information

Product Name	Package	Marking
OSG65R060PT4ZF	TO220	OSG65R060PT4Z

Package & Pin Information

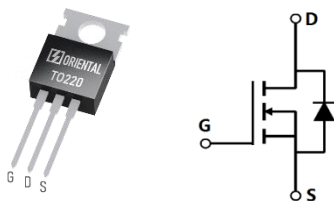

Absolute Maximum Ratings at $T_j=25^\circ\text{C}$ unless otherwise noted

Parameter	Symbol	Value	Unit
Drain-source voltage	V_{DS}	650	V
Gate-source voltage (static)	V_{GS}	± 20	V
Gate-source voltage (dynamic)		± 30	V
Continuous drain current ¹⁾ , $T_C=25^\circ\text{C}$	I_D	50	A
Continuous drain current ¹⁾ , $T_C=100^\circ\text{C}$		31.6	
Pulsed drain current ²⁾ , $T_C=25^\circ\text{C}$	$I_{D, pulse}$	150	A
Continuous diode forward current ¹⁾ , $T_C=25^\circ\text{C}$	I_S	50	A
Diode pulsed current ²⁾ , $T_C=25^\circ\text{C}$	$I_{S, pulse}$	150	A
Power dissipation ³⁾ , $T_C=25^\circ\text{C}$	P_D	370	W
Single pulsed avalanche energy ⁴⁾	E_{AS}	518	mJ
MOSFET dv/dt ruggedness, $V_{DS}=0\dots 400\text{ V}$	dv/dt	100	V/ns
Reverse diode dv/dt, $V_{DS}=0\dots 400\text{ V}$, $I_{SD}\leq I_D$	dv/dt	50	V/ns
Operation and storage temperature	T_{stg}, T_j	-55 to 150	$^\circ\text{C}$

Thermal Characteristics

Parameter	Symbol	Value	Unit
Thermal resistance, junction-case	$R_{\theta JC}$	0.34	$^\circ\text{C/W}$
Thermal resistance, junction-ambient	$R_{\theta JA}$	62	$^\circ\text{C/W}$

Electrical Characteristics at $T_j=25^\circ\text{C}$ unless otherwise specified

Parameter	Symbol	Min.	Typ.	Max.	Unit	Test condition
Drain-source breakdown voltage	BV_{DSS}	650			V	$V_{GS}=0\text{ V}$, $I_D=1\text{ mA}$
Gate threshold voltage	$V_{GS(th)}$	3.5		5.5	V	$V_{DS}=V_{GS}$, $I_D=1\text{ mA}$
Drain-source on-state resistance	$R_{DS(ON)}$		49.8	60	m Ω	$V_{GS}=10\text{ V}$, $I_D=25\text{ A}$
			130			$V_{GS}=10\text{ V}$, $I_D=25\text{ A}$, $T_j=150^\circ\text{C}$
Gate-source leakage current	I_{GSS}			100	nA	$V_{GS}=20\text{ V}$
				-100		$V_{GS}=-20\text{ V}$
Drain-source leakage current	I_{DSS}			10	μA	$V_{DS}=650\text{ V}$, $V_{GS}=0\text{ V}$
Gate resistance	R_G		2.6		Ω	$f=1\text{ MHz}$, Open drain

Dynamic Characteristics

Parameter	Symbol	Min.	Typ.	Max.	Unit	Test condition
Input capacitance	C_{iss}		3283		pF	$V_{GS}=0\text{ V}$, $V_{DS}=50\text{ V}$, $f=100\text{ kHz}$
Output capacitance	C_{oss}		205		pF	
Reverse transfer capacitance	C_{rss}		3.3		pF	
Effective output capacitance, energy related	$C_{o(er)}$		137		pF	$V_{GS}=0\text{ V}$, $V_{DS}=0\text{ V-400 V}$
Effective output capacitance, time related	$C_{o(tr)}$		871		pF	
Turn-on delay time	$t_{d(on)}$		23.2		ns	$V_{GS}=10\text{ V}$, $V_{DS}=400\text{ V}$, $R_G=2\ \Omega$, $I_D=26\text{ A}$
Rise time	t_r		9.6		ns	
Turn-off delay time	$t_{d(off)}$		47.2		ns	
Fall time	t_f		2.3		ns	

Gate Charge Characteristics

Parameter	Symbol	Min.	Typ.	Max.	Unit	Test condition
Total gate charge	Q_g		65.7		nC	$V_{GS}=10\text{ V}$, $V_{DS}=400\text{ V}$, $I_D=26\text{ A}$
Gate-source charge	Q_{gs}		21.6		nC	
Gate-drain charge	Q_{gd}		27		nC	
Gate plateau voltage	$V_{plateau}$		7.1		V	

Body Diode Characteristics

Parameter	Symbol	Min.	Typ.	Max.	Unit	Test condition
Diode forward voltage	V_{SD}			1.3	V	$I_S=50\text{ A}$, $V_{GS}=0\text{ V}$
Reverse recovery time	t_{rr}		179		ns	$V_R=400\text{ V}$, $I_S=26\text{ A}$, $di/dt=100\text{ A}/\mu\text{s}$
Reverse recovery charge	Q_{rr}		1.1		μC	
Peak reverse recovery current	I_{rrm}		10.3		A	

Note

- 1) Calculated continuous current based on maximum allowable junction temperature.
- 2) Repetitive rating; pulse width limited by max. junction temperature.
- 3) P_d is based on max. junction temperature, using junction-case thermal resistance.
- 4) $V_{DD}=100\text{ V}$, $V_{GS}=10\text{ V}$, $L=80\text{ mH}$, starting $T_j=25\text{ }^\circ\text{C}$.

Electrical Characteristics Diagrams

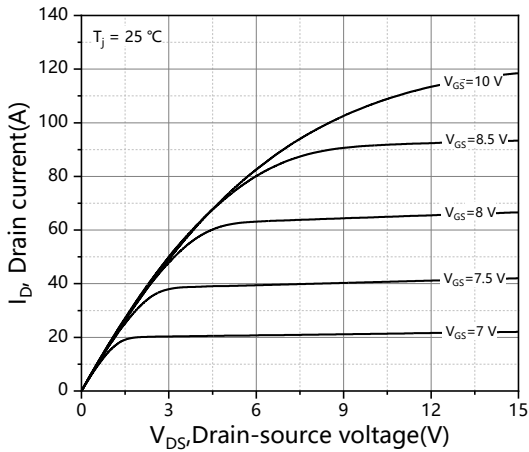

Figure 1. Typ. output characteristics $T_j=25^\circ\text{C}$

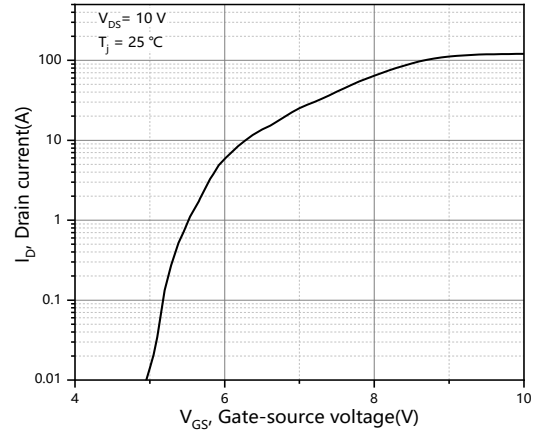

Figure 2. Typ. transfer characteristics

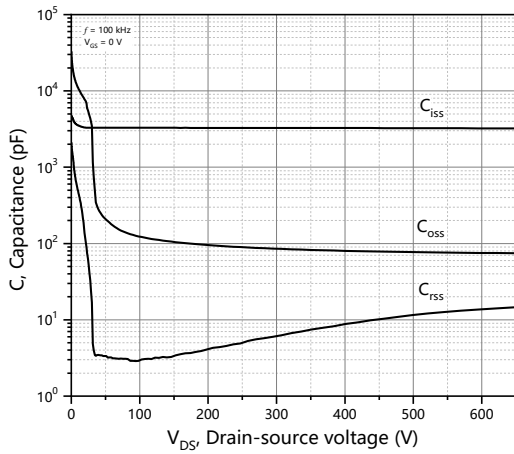

Figure 3. Typ. capacitances

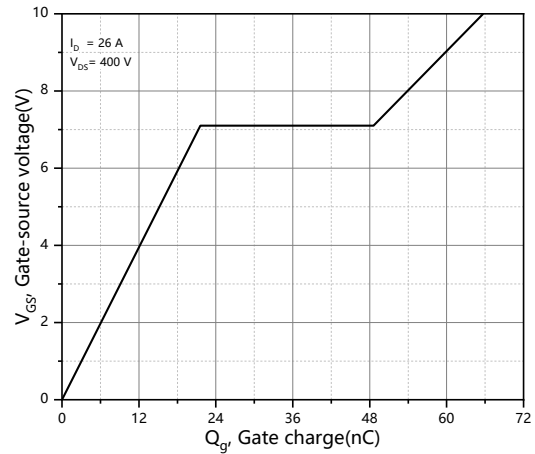

Figure 4. Typ. gate charge

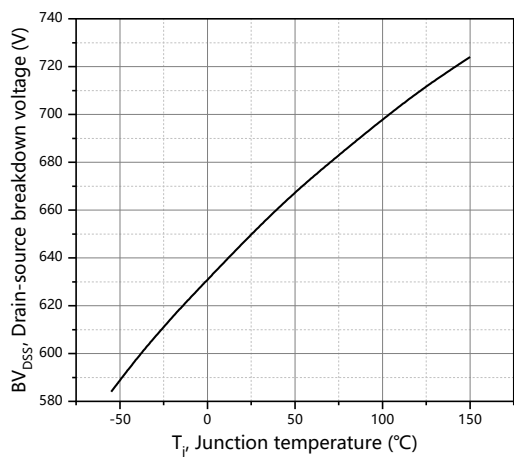

Figure 5. Drain-source breakdown voltage

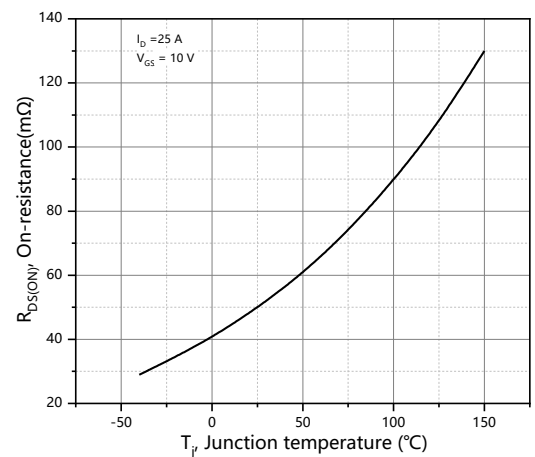
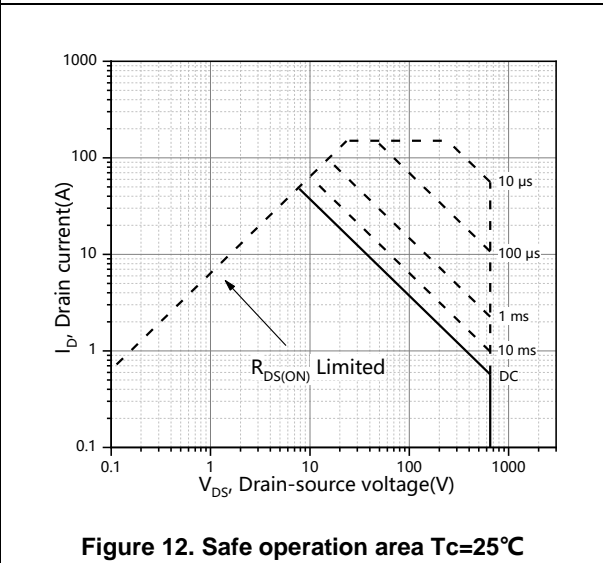
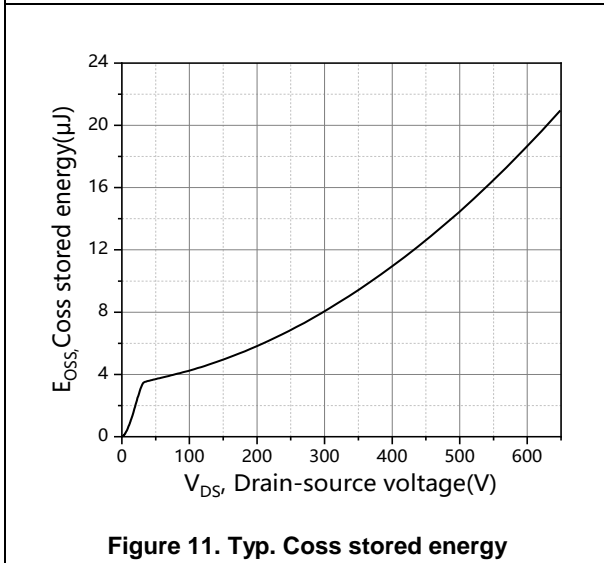
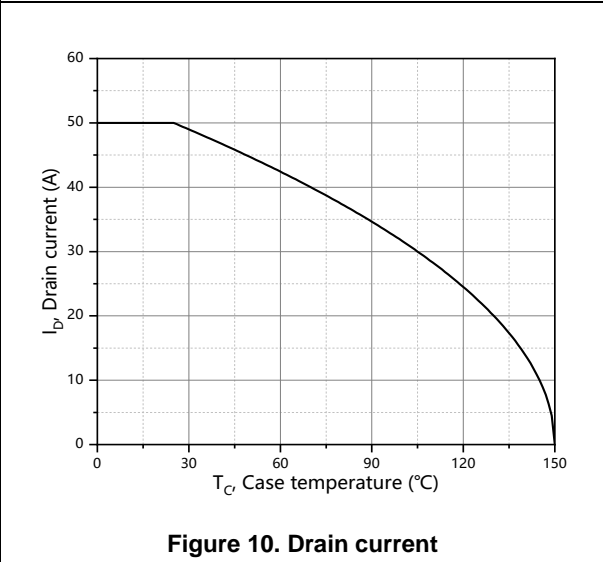
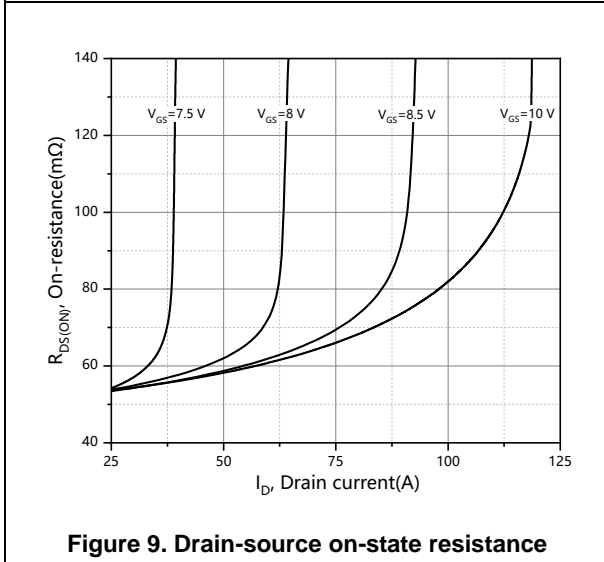
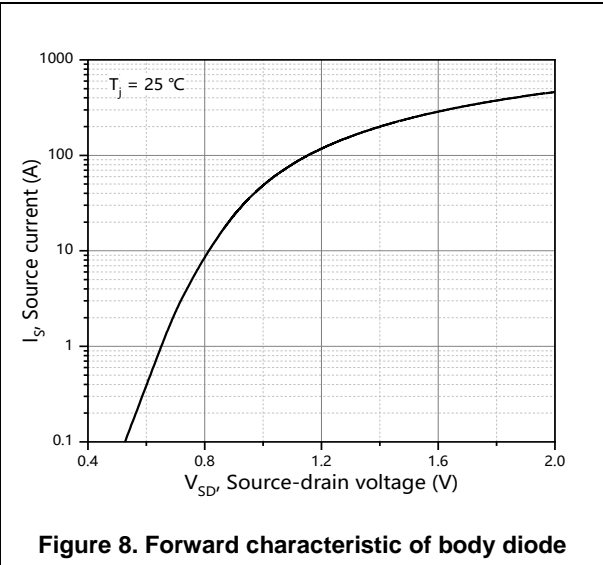
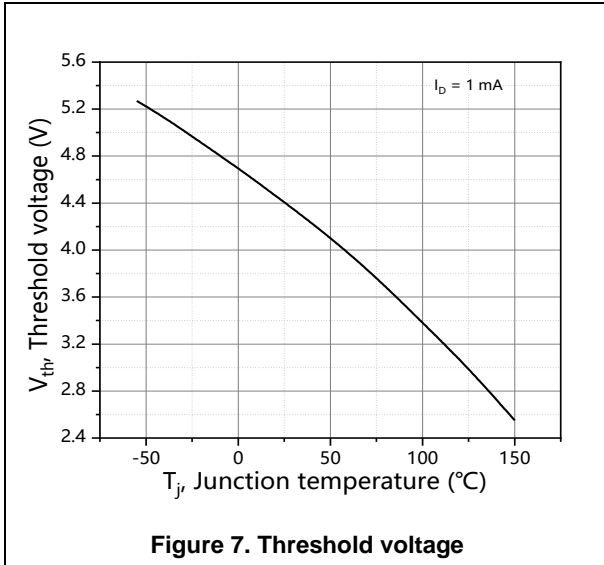
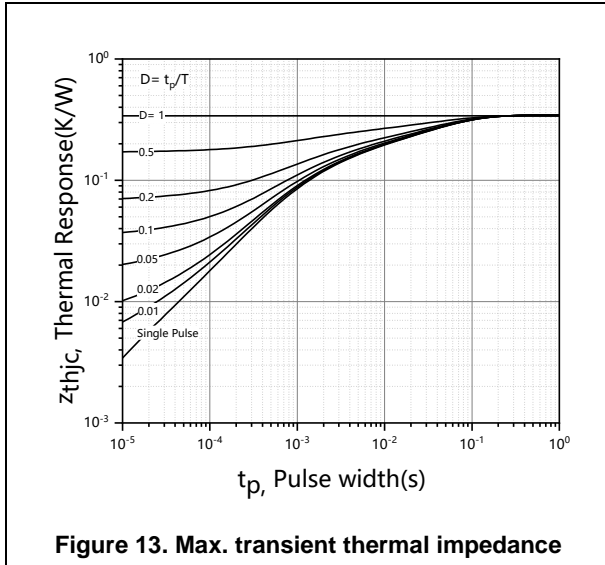

Figure 6. Drain-source on-state resistance





Test circuits and waveforms



Figure 1. Gate charge test circuit & waveform



Figure 2. Switching time test circuit & waveforms

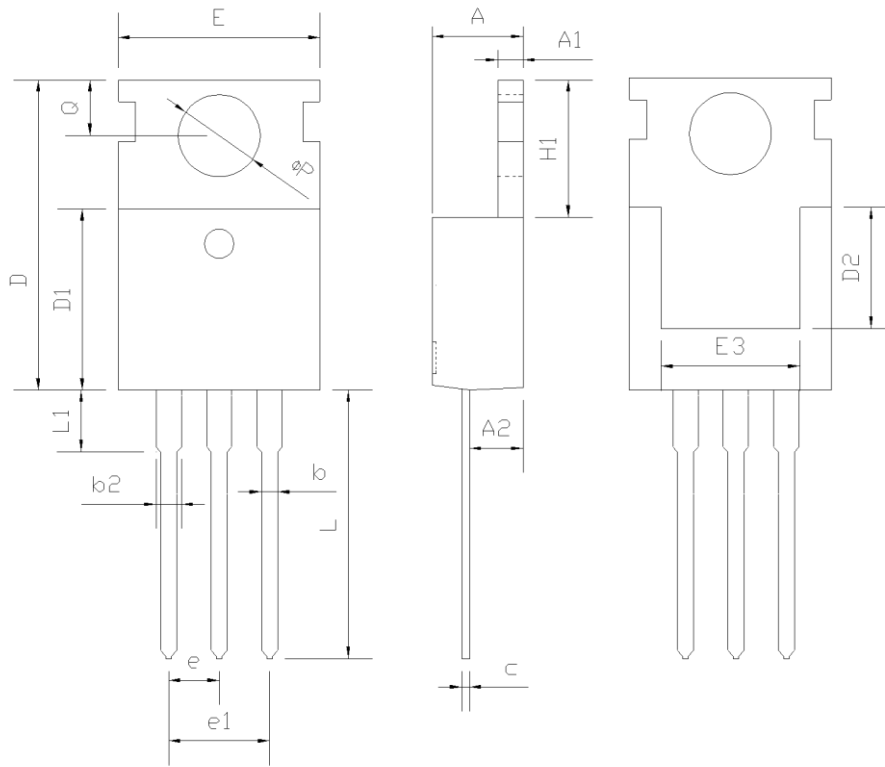

Figure 3. Unclamped inductive switching (UIS) test circuit & waveforms



Figure 4. Diode reverse recovery test circuit & waveforms

Package Information



Symbol	mm		
	Min	Nom	Max
A	4.37	4.57	4.77
A1	1.25	1.30	1.45
A2	2.20	2.40	2.60
b	0.70	0.80	0.95
b2	1.17	1.27	1.47
c	0.40	0.50	0.65
D	15.10	15.60	16.10
D1	8.80	9.10	9.40
D2	5.50	-	-
E	9.70	10.00	10.30
E3	7.00	-	-
e	2.54 BSC		
e1	5.08 BSC		
H1	6.25	6.50	6.85
L	12.75	13.50	13.80
L1	-	3.10	3.40
ΦP	3.40	3.60	3.80
Q	2.60	2.80	3.00

Version : TO220-P package outline dimension

Ordering Information

Package Type	Units/ Tube	Tubes/ Inner Box	Units/ Inner Box	Inner Boxes/ Carton Box	Units/ Carton Box
TO220-P	50	20	1000	6	6000

Product Information

Product	Package	Pb Free	RoHS	Halogen Free
OSG65R060PT4ZF	TO220	yes	yes	yes

Legal Disclaimer

The information given in this document shall in no event be regarded as a guarantee of conditions or characteristics. With respect to any examples or hints given herein, any typical values stated herein and/or any information regarding the application of the device, Oriental Semiconductor hereby disclaims any and all warranties and liabilities of any kind, including without limitation, warranties of non-infringement of intellectual property rights of any third party.

For further information on technology, delivery terms and conditions and prices, please contact the Oriental Semiconductor sales representatives (www.orientalsemi.com).

© Oriental Semiconductor Co.,Ltd. All Rights Reserved 

Revision History

Version	Revision History	Date
V1.0	Initial release	2025-08-27