

General Description

The GreenMOS[®] high voltage MOSFET utilizes charge balance technology to achieve outstanding low on-resistance and lower gate charge. It is engineered to minimize conduction loss, provide superior switching performance and robust avalanche capability.

The GreenMOS[®] Generic series is optimized for extreme switching performance to minimize switching loss. It is tailored for high power density applications to meet the highest efficiency standards.

Features

- Low $R_{DS(ON)}$ & FOM
- Extremely low switching loss
- Excellent stability and uniformity



Applications

- PC power
- LED lighting
- Telecom power
- Server power
- EV Charger
- Solar/UPS

Key Performance Parameters

Parameter	Value	Unit
V_{DS}	800	V
I_D , pulse	15	A
$R_{DS(ON)}$, max @ $V_{GS}=10V$	900	m Ω
Q_g	11.7	nC

Marking Information

Product Name	Package	Marking
OSG80R900FF	TO220F	OSG80R900F

Package & Pin Information

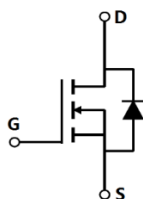

Absolute Maximum Ratings at $T_j=25^{\circ}\text{C}$ unless otherwise noted

Parameter	Symbol	Value	Unit
Drain-source voltage	V_{DS}	800	V
Gate-source voltage	V_{GS}	± 30	V
Continuous drain current ¹⁾ , $T_C=25^{\circ}\text{C}$	I_D	5	A
Continuous drain current ¹⁾ , $T_C=100^{\circ}\text{C}$		3.2	
Pulsed drain current ²⁾ , $T_C=25^{\circ}\text{C}$	$I_{D, pulse}$	15	A
Continuous diode forward current ¹⁾ , $T_C=25^{\circ}\text{C}$	I_S	5	A
Diode pulsed current ²⁾ , $T_C=25^{\circ}\text{C}$	$I_{S, pulse}$	15	A
Power dissipation ³⁾ , $T_C=25^{\circ}\text{C}$	P_D	28	W
Single pulsed avalanche energy ⁴⁾	E_{AS}	160	mJ
MOSFET dv/dt ruggedness, $V_{DS}=0\dots 640\text{ V}$	dv/dt	50	V/ns
Reverse diode dv/dt, $V_{DS}=0\dots 640\text{ V}$, $I_{SD}\leq I_D$	dv/dt	15	V/ns
Operation and storage temperature	T_{stg}, T_j	-55 to 150	$^{\circ}\text{C}$

Thermal Characteristics

Parameter	Symbol	Value	Unit
Thermal resistance, junction-case	$R_{\theta JC}$	4.5	$^{\circ}\text{C/W}$
Thermal resistance, junction-ambient	$R_{\theta JA}$	62.5	$^{\circ}\text{C/W}$

Electrical Characteristics at $T_j=25^{\circ}\text{C}$ unless otherwise specified

Parameter	Symbol	Min.	Typ.	Max.	Unit	Test condition
Drain-source breakdown voltage	BV_{DSS}	800			V	$V_{GS}=0\text{ V}$, $I_D=250\ \mu\text{A}$
Gate threshold voltage	$V_{GS(th)}$	2.9		3.9	V	$V_{DS}=V_{GS}$, $I_D=250\ \mu\text{A}$
Drain-source on-state resistance	$R_{DS(ON)}$		0.8	0.9	Ω	$V_{GS}=10\text{ V}$, $I_D=2.5\text{ A}$
			2.1			$V_{GS}=10\text{ V}$, $I_D=2.5\text{ A}$, $T_j=150^{\circ}\text{C}$
Gate-source leakage current	I_{GSS}			100	nA	$V_{GS}=30\text{ V}$
				-100		$V_{GS}=-30\text{ V}$
Drain-source leakage current	I_{DSS}			1	μA	$V_{DS}=800\text{ V}$, $V_{GS}=0\text{ V}$

Dynamic Characteristics

Parameter	Symbol	Min.	Typ.	Max.	Unit	Test condition
Input capacitance	C_{iss}		647.4		pF	$V_{GS}=0\text{ V}$, $V_{DS}=50\text{ V}$, $f=100\text{ kHz}$
Output capacitance	C_{oss}		36.1		pF	
Reverse transfer capacitance	C_{rss}		1.5		pF	
Turn-on delay time	$t_{d(on)}$		31.3		ns	$V_{GS}=10\text{ V}$, $V_{DS}=400\text{ V}$, $R_G=2\ \Omega$, $I_D=4\text{ A}$
Rise time	t_r		16.4		ns	
Turn-off delay time	$t_{d(off)}$		54.6		ns	
Fall time	t_f		7.0		ns	

Gate Charge Characteristics

Parameter	Symbol	Min.	Typ.	Max.	Unit	Test condition
Total gate charge	Q_g		11.7		nC	$V_{GS}=10\text{ V}$, $V_{DS}=400\text{ V}$, $I_D=4\text{ A}$
Gate-source charge	Q_{gs}		2.8		nC	
Gate-drain charge	Q_{gd}		4.4		nC	
Gate plateau voltage	$V_{plateau}$		5.8		V	

Body Diode Characteristics

Parameter	Symbol	Min.	Typ.	Max.	Unit	Test condition
Diode forward voltage	V_{SD}			1.3	V	$I_S=5\text{ A}$, $V_{GS}=0\text{ V}$
Reverse recovery time	t_{rr}		216.5		ns	$V_R=400\text{ V}$, $I_S=4\text{ A}$, $di/dt=100\text{ A}/\mu\text{s}$
Reverse recovery charge	Q_{rr}		1.9		μC	
Peak reverse recovery current	I_{rrm}		17.0		A	

Note

- 1) Calculated continuous current based on maximum allowable junction temperature.
- 2) Repetitive rating; pulse width limited by max. junction temperature.
- 3) P_d is based on max. junction temperature, using junction-case thermal resistance.
- 4) $V_{DD}=100\text{ V}$, $V_{GS}=10\text{ V}$, $L=60\text{ mH}$, starting $T_j=25\text{ }^\circ\text{C}$.

Electrical Characteristics Diagrams

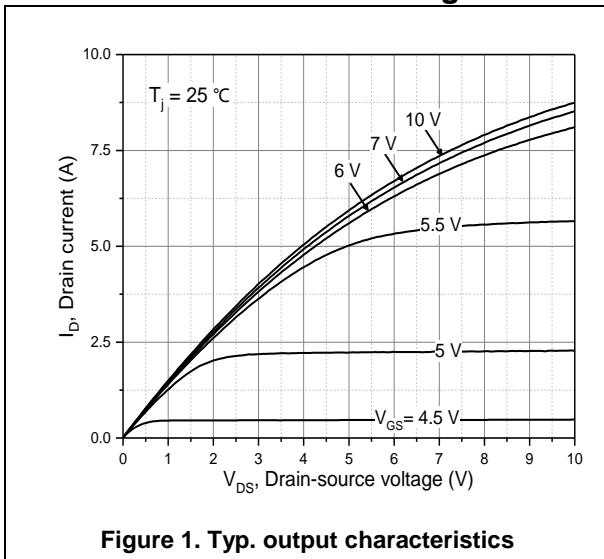

Figure 1. Typ. output characteristics

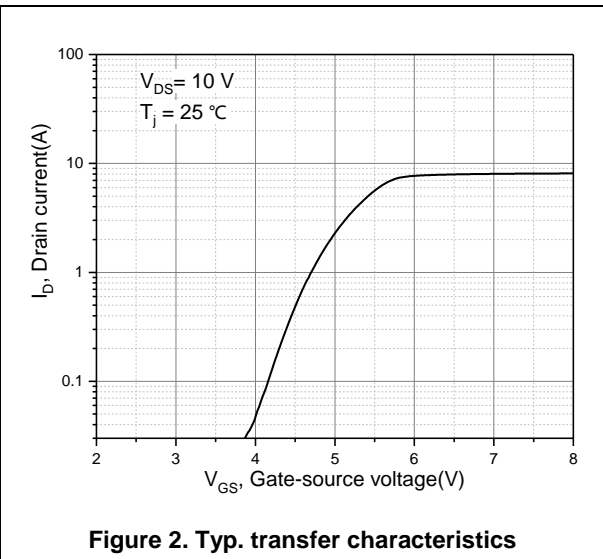

Figure 2. Typ. transfer characteristics

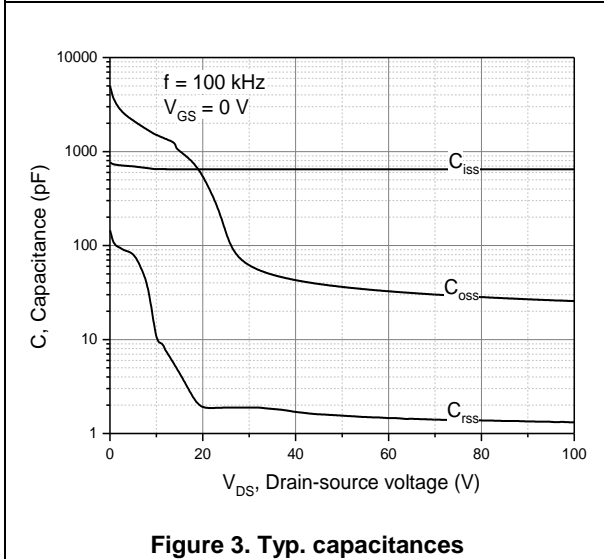

Figure 3. Typ. capacitances

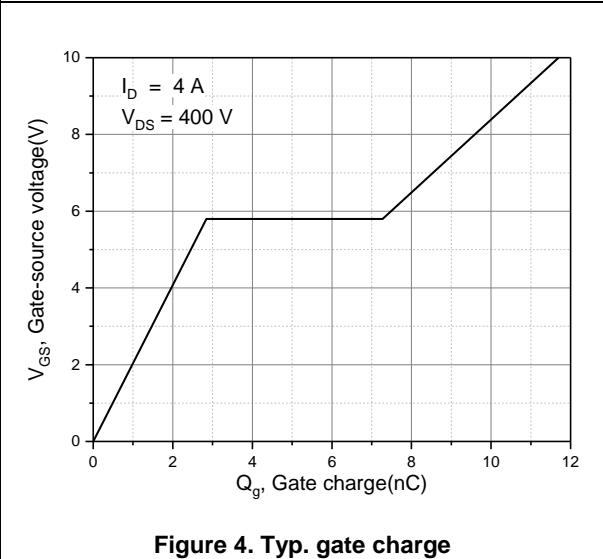

Figure 4. Typ. gate charge

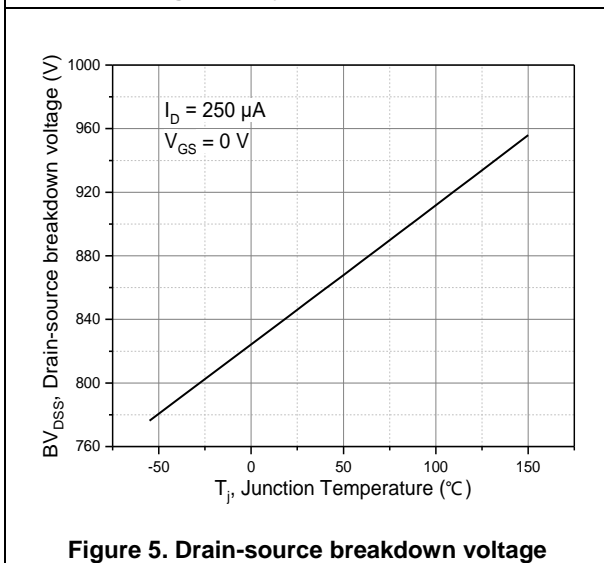

Figure 5. Drain-source breakdown voltage

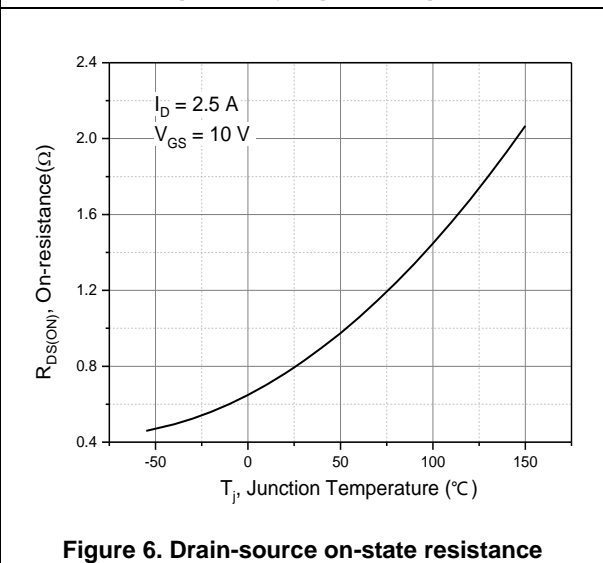
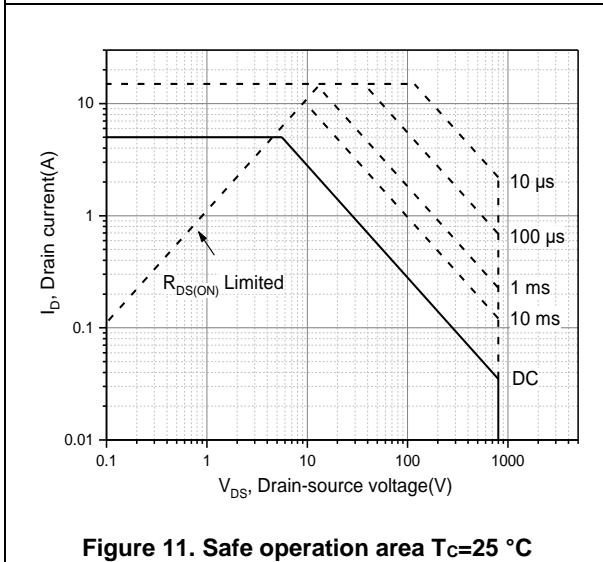
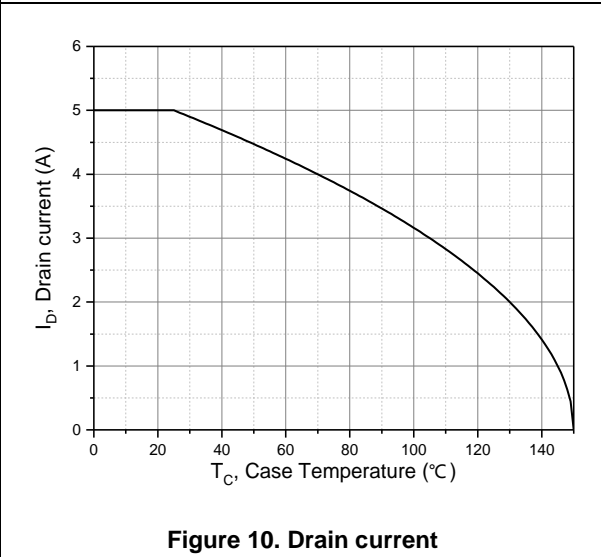
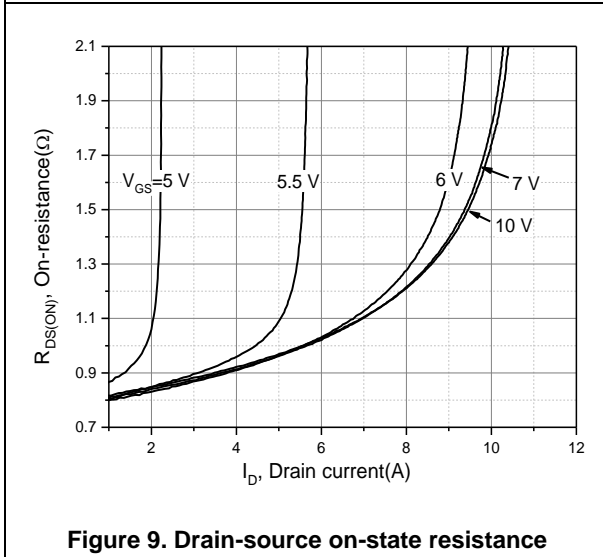
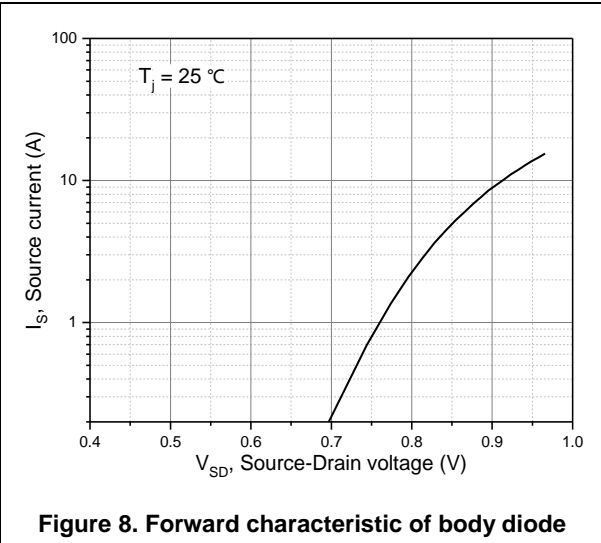
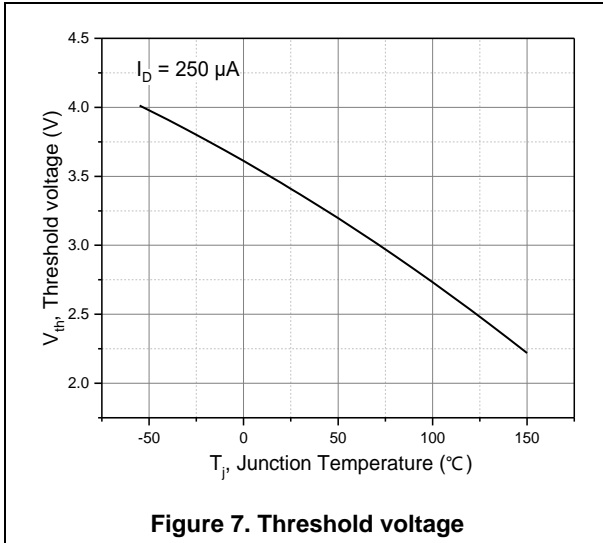

Figure 6. Drain-source on-state resistance



Test circuits and waveforms



Figure 1. Gate charge test circuit & waveform



Figure 2. Switching time test circuit & waveforms

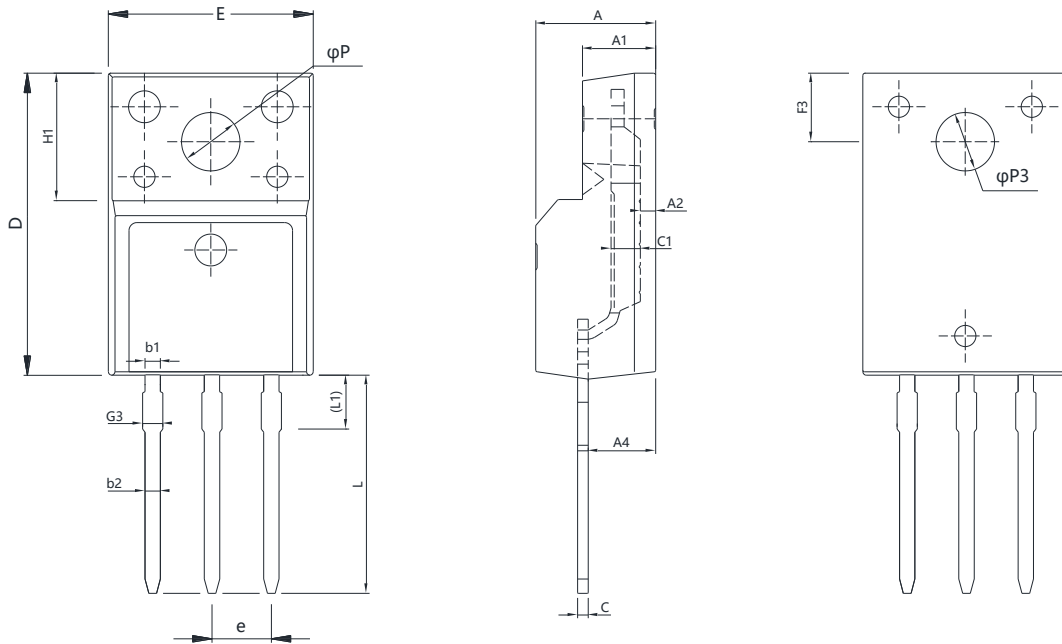

Figure 3. Unclamped inductive switching (UIS) test circuit & waveforms



Figure 4. Diode reverse recovery test circuit & waveforms

Package Information



Symbol	mm		
	Min	Nom	Max
E	9.96	10.16	10.36
A	4.50	4.70	4.90
A1	2.34	2.54	2.74
A2	0.30	0.45	0.60
A4	2.56	2.76	2.96
c	0.40	0.50	0.65
C1	1.20	1.30	1.35
D	15.57	15.87	16.17
H1	6.70REF		
e	2.54BSC		
L	12.68	12.98	13.28
L1	2.88	3.03	3.18
φP	3.03	3.18	3.38
φP3	3.15	3.45	3.65
F3	3.15	3.30	3.45
G3	1.25	1.35	1.55
b1	1.18	1.28	1.43
b2	0.70	0.80	0.95

Version 1: TO220F-P package outline dimension

Ordering Information

Package Type	Units/ Tube	Tubes/ Inner Box	Units/ Inner Box	Inner Boxes/ Carton Box	Units/ Carton Box
TO220F-P	50	20	1000	6	6000

Product Information

Product	Package	Pb Free	RoHS	Halogen Free
OSG80R900FF	TO220F	yes	yes	yes

Legal Disclaimer

The information given in this document shall in no event be regarded as a guarantee of conditions or characteristics. With respect to any examples or hints given herein, any typical values stated herein and/or any information regarding the application of the device, Oriental Semiconductor hereby disclaims any and all warranties and liabilities of any kind, including without limitation, warranties of non-infringement of intellectual property rights of any third party.

For further information on technology, delivery terms and conditions and prices, please contact the Oriental Semiconductor sales representatives (www.orientalsemi.com).

© Oriental Semiconductor Co.,Ltd. All Rights Reserved 