

## General Description

OST50N75HLMF uses advanced Oriental-Semi's patented Trident-Gate Bipolar Transistor (TGBT™) technology to provide extremely low  $V_{CE(sat)}$ , low gate charge, and excellent switching performance. This device is suitable for mid to high range switching frequency converters.

## Features

- Advanced TGBT™ technology
- Excellent conduction and switching loss
- Excellent stability and uniformity
- Fast and soft antiparallel diode



## Applications

- Induction converters
- Uninterruptible power supplies

## Key Performance Parameters

Parameter	Value	Unit
$V_{CES, min}$ @ 25 °C	750	V
Maximum junction temperature	175	°C
$I_C, pulse$	200	A
$V_{CE(sat), typ}$ @ $V_{GE}=15$ V	1.3	V
$Q_g$	99	nC

## Marking Information

Product Name	Package	Marking
OST50N75HLMF	TO247	OST50N75HLM

## Package & Pin Information

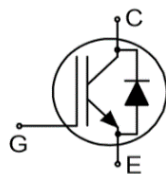

**Absolute Maximum Ratings** at  $T_{vj}=25\text{ °C}$  unless otherwise noted

Parameter	Symbol	Value	Unit
Collector emitter voltage	$V_{CES}$	750	V
Gate emitter voltage	$V_{GES}$	$\pm 20$	V
Transient gate emitter voltage, $T_P \leq 10\ \mu s$ , $D < 0.01$		$\pm 30$	V
Continuous collector current <sup>1)</sup> , $T_C=25\text{ °C}$	$I_C$	80	A
Continuous collector current <sup>1)</sup> , $T_C=100\text{ °C}$		50	A
Pulsed collector current <sup>2)</sup> , $T_C=25\text{ °C}$	$I_{C, pulse}$	200	A
Diode forward current <sup>1)</sup> , $T_C=25\text{ °C}$	$I_F$	80	A
Diode forward current <sup>1)</sup> , $T_C=100\text{ °C}$		50	A
Diode pulsed current <sup>2)</sup> , $T_C=25\text{ °C}$	$I_{F, pulse}$	200	A
Power dissipation <sup>3)</sup> , $T_C=25\text{ °C}$	$P_D$	375	W
Power dissipation <sup>3)</sup> , $T_C=100\text{ °C}$		188	W
Operation and storage temperature	$T_{stg}, T_{vj}$	-55 to 175	°C

**Thermal Characteristics**

Parameter	Symbol	Value	Unit
IGBT thermal resistance, junction-case	$R_{\theta JC}$	0.4	°C/W
Diode thermal resistance, junction-case	$R_{\theta JC}$	0.6	°C/W
Thermal resistance, junction-ambient	$R_{\theta JA}$	40	°C/W

**Electrical Characteristics** at  $T_{vj}=25\text{ °C}$  unless otherwise specified

Parameter	Symbol	Min.	Typ.	Max.	Unit	Test condition
Collector-emitter breakdown voltage	$V_{(BR)CES}$	750			V	$V_{GE}=0\text{ V}$ , $I_C=0.5\text{ mA}$
Collector-emitter saturation voltage	$V_{CE(sat)}$		1.3	1.5	V	$V_{GE}=15\text{ V}$ , $I_C=50\text{ A}$ $T_{vj}=25\text{ °C}$
			1.4		V	$V_{GE}=15\text{ V}$ , $I_C=50\text{ A}$ , $T_{vj}=125\text{ °C}$
			1.46		V	$V_{GE}=15\text{ V}$ , $I_C=50\text{ A}$ , $T_{vj}=175\text{ °C}$
Gate-emitter threshold voltage	$V_{GE(th)}$	3.5	4.0	4.5	V	$V_{CE}=V_{GE}$ , $I_C=0.5\text{ mA}$
Diode forward voltage	$V_F$		1.8		V	$V_{GE}=0\text{ V}$ , $I_F=50\text{ A}$ $T_{vj}=25\text{ °C}$
			1.48		V	$V_{GE}=0\text{ V}$ , $I_F=50\text{ A}$ , $T_{vj}=125\text{ °C}$
			1.38		V	$V_{GE}=0\text{ V}$ , $I_F=50\text{ A}$ , $T_{vj}=175\text{ °C}$
Gate-emitter leakage current	$I_{GES}$			100	nA	$V_{CE}=0\text{ V}$ , $V_{GE}=20\text{ V}$
Zero gate voltage collector current	$I_{CES}$			10	$\mu\text{A}$	$V_{CE}=750\text{ V}$ , $V_{GE}=0\text{ V}$

### Dynamic Characteristics

Parameter	Symbol	Min.	Typ.	Max.	Unit	Test condition
Input capacitance	$C_{ies}$		5280		pF	$V_{GE}=0\text{ V}$ , $V_{CE}=25\text{ V}$ , $f=100\text{ kHz}$
Output capacitance	$C_{oes}$		159		pF	
Reverse transfer capacitance	$C_{res}$		4		pF	
Turn-on delay time	$t_{d(on)}$		31		ns	$V_{GE}=15\text{ V}$ , $V_{CC}=450\text{ V}$ , $R_G=10\ \Omega$ , $I_C=50\text{ A}$
Rise time	$t_r$		32		ns	
Turn-off delay time	$t_{d(off)}$		133		ns	
Fall time	$t_f$		49		ns	
Turn-on energy	$E_{on}$		1.23		mJ	
Turn-off energy	$E_{off}$		1.02		mJ	
Turn-on delay time	$t_{d(on)}$		29		ns	$V_{GE}=15\text{ V}$ , $V_{CC}=450\text{ V}$ , $R_G=10\ \Omega$ , $I_C=25\text{ A}$
Rise time	$t_r$		13		ns	
Turn-off delay time	$t_{d(off)}$		164		ns	
Fall time	$t_f$		43		ns	
Turn-on energy	$E_{on}$		0.56		mJ	
Turn-off energy	$E_{off}$		0.51		mJ	

### Gate Charge Characteristics

Parameter	Symbol	Min.	Typ.	Max.	Unit	Test condition
Total gate charge	$Q_g$		99		nC	$V_{GE}=15\text{ V}$ , $V_{CC}=520\text{ V}$ , $I_C=50\text{ A}$
Gate-emitter charge	$Q_{ge}$		36		nC	
Gate-collector charge	$Q_{gc}$		20		nC	

### Body Diode Characteristics

Parameter	Symbol	Min.	Typ.	Max.	Unit	Test condition
Diode reverse recovery time	$t_{rr}$		153		ns	$V_R=450\text{ V}$ , $I_F=50\text{ A}$ , $di_F/dt=500\text{ A}/\mu\text{s}$ $T_{vj}=25\text{ }^\circ\text{C}$
Diode reverse recovery charge	$Q_{rr}$		1.61		$\mu\text{C}$	
Diode peak reverse recovery current	$I_{rrm}$		19		A	

#### Note

- 1) Calculated continuous current based on maximum allowable junction temperature.
- 2) Repetitive rating; pulse width limited by max. junction temperature.
- 3)  $P_d$  is based on max. junction temperature, using junction-case thermal resistance.

**Electrical Characteristics Diagrams**

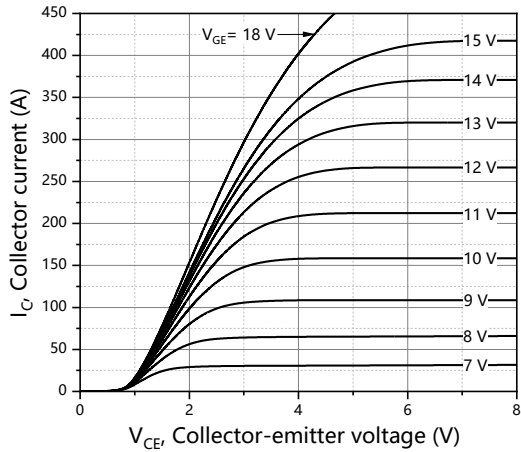

**Figure 1. Typical output characteristics**  
( $T_{vj}=25\text{ }^{\circ}\text{C}$ )

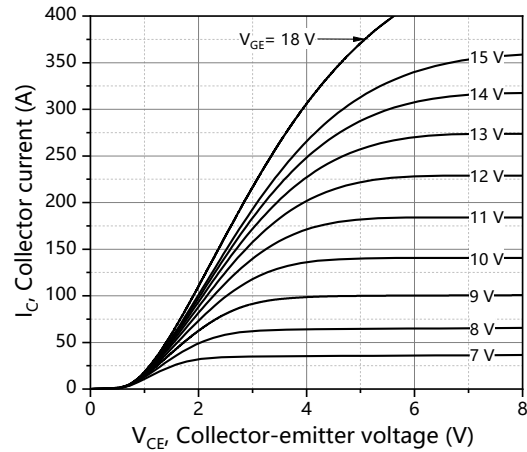

**Figure 2. Typical output characteristics**  
( $T_{vj}=150\text{ }^{\circ}\text{C}$ )

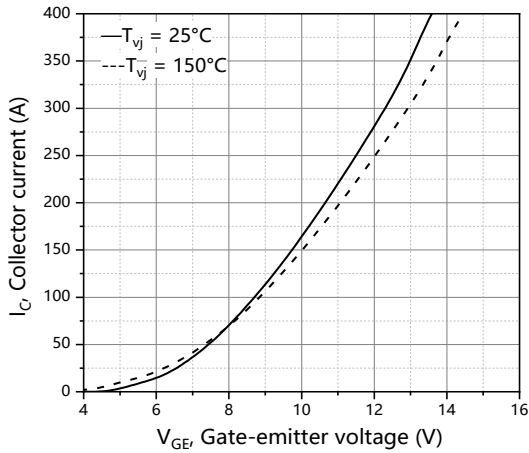

**Figure 3. Typical transfer characteristics**  
( $V_{CE}=20\text{ V}$ )

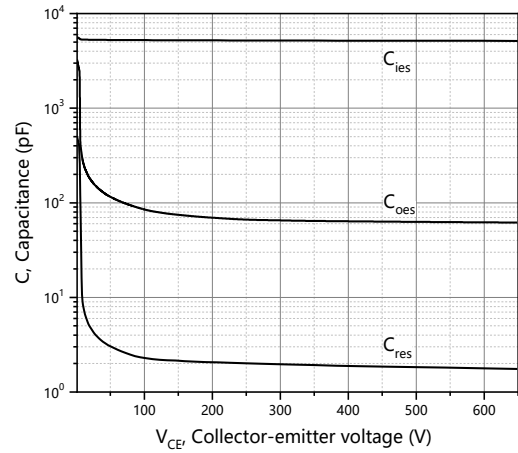

**Figure 4. Typical capacitance**  
( $V_{GE}=0\text{ V}$ ,  $f=100\text{ kHz}$ )

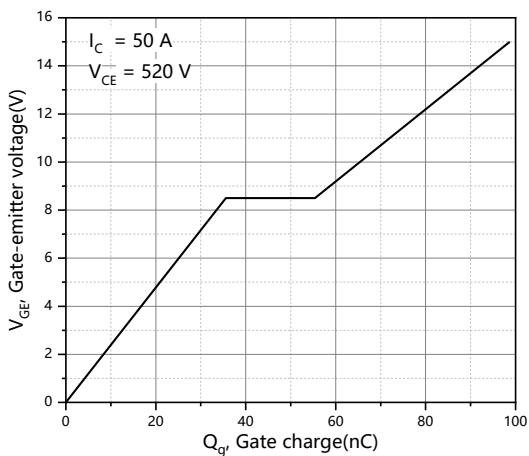

**Figure 5. Typical gate charge**

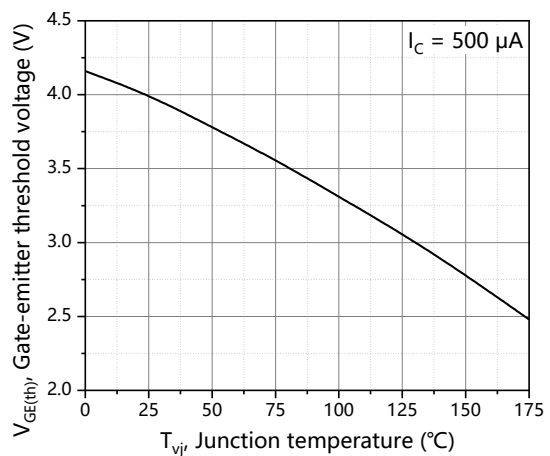

**Figure 6. Gate-emitter threshold voltage**

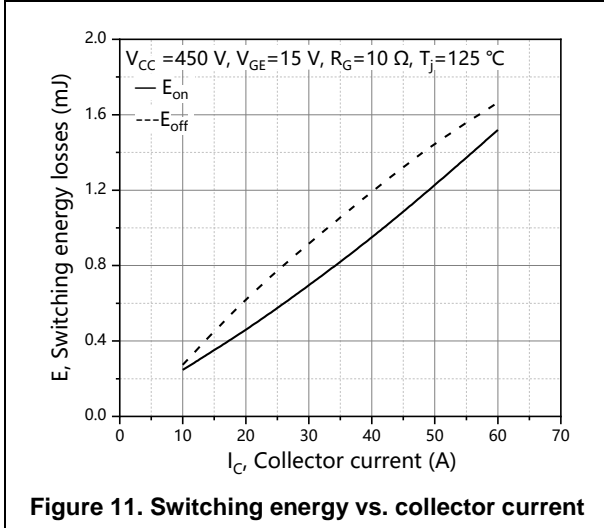
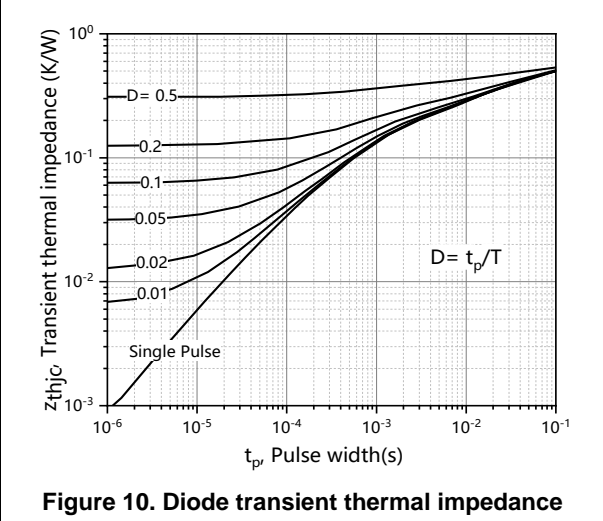
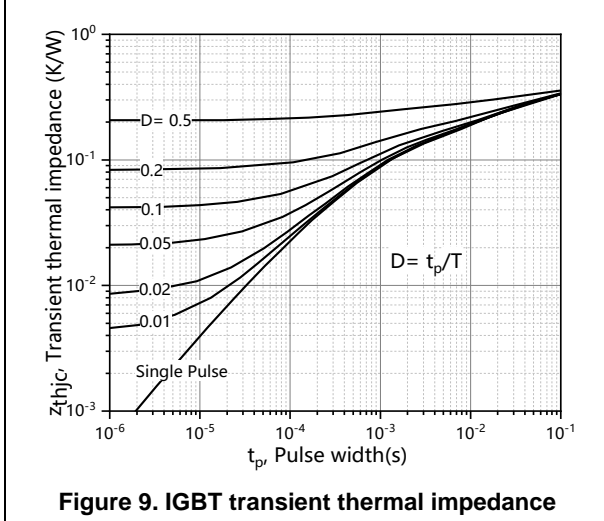
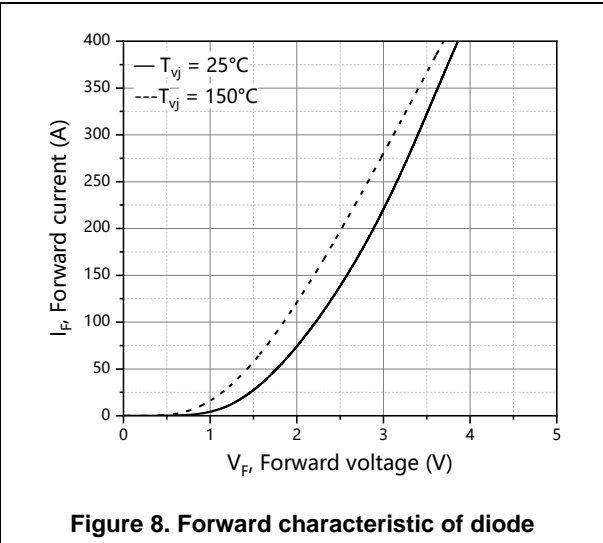
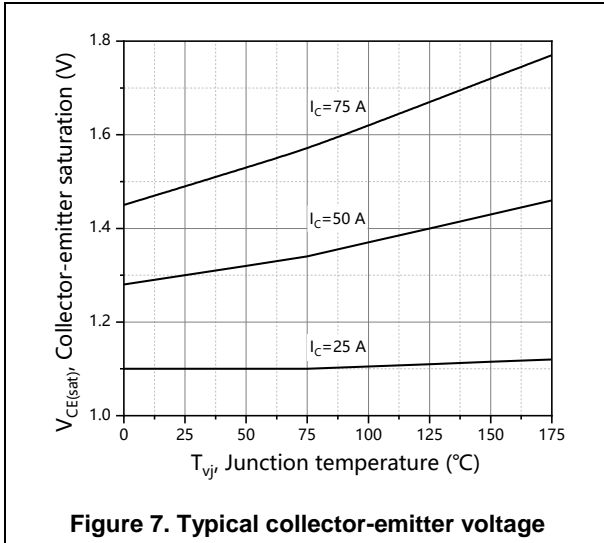

**Package Information**

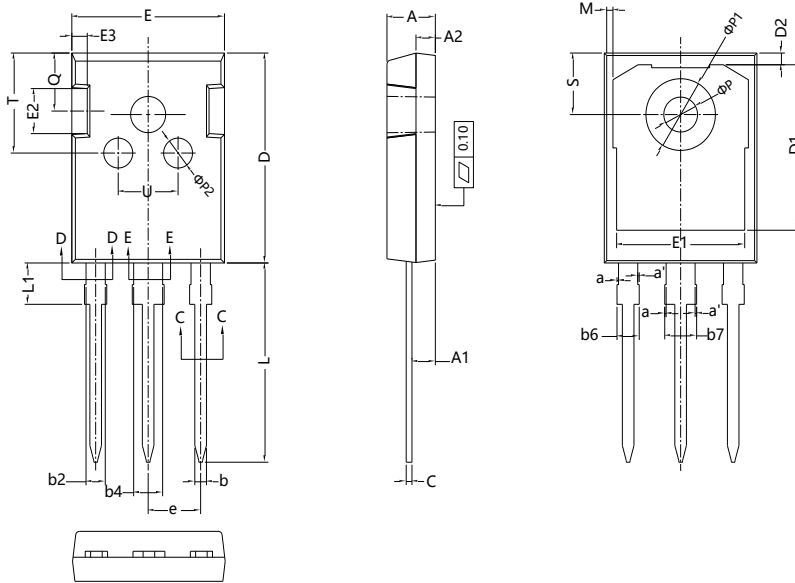

Symbol	mm		
	Min	Nom	Max
A	4.90	5.00	5.10
A1	2.31	2.41	2.51
A2	1.90	2.00	2.10
a	0.00	-	0.15
a'	0.00	-	0.15
b	1.16	-	1.26
b2	1.96	-	2.06
b4	2.96	-	3.06
b6	-	-	2.25
b7	-	-	3.25
c	0.59	-	0.66
D	20.90	21.00	21.10
D1	16.25	16.55	16.85
D2	1.05	1.17	1.35
E	15.70	15.80	15.90
E1	13.10	13.30	13.50
E2	4.40	4.50	4.60
E3	1.50	1.60	1.70
e	5.436 BSC		
L	19.80	19.92	20.10
L1	-	-	4.30
M	0.35	-	0.95
P	3.40	3.50	3.60
P1	7.00	-	7.40
P2	2.40	2.5	2.6
Q	5.60	-	6.0
S	6.05	6.15	6.25
T	9.8	-	10.20
U	6.00	-	6.40

Version : TO247-J package outline dimension

### Ordering Information

Package Type	Units/ Tube	Tubes/ Inner Box	Units/ Inner Box	Inner Boxes/ Carton Box	Units/ Carton Box
TO247-J	30	20	600	4	2400

### Product Information

Product	Package	Pb Free	RoHS	Halogen Free
OST50N75HLMF	TO247	yes	yes	yes

### Legal Disclaimer

The information given in this document shall in no event be regarded as a guarantee of conditions or characteristics. With respect to any examples or hints given herein, any typical values stated herein and/or any information regarding the application of the device, Oriental Semiconductor hereby disclaims any and all warranties and liabilities of any kind, including without limitation, warranties of non-infringement of intellectual property rights of any third party.

For further information on technology, delivery terms and conditions and prices, please contact the Oriental Semiconductor sales representatives ([www.orientalsemi.com](http://www.orientalsemi.com)).

© Oriental Semiconductor Co.,Ltd. All Rights Reserved 

## Revision History

Version	Revision History	Data
V1.0	Initial release	2025-06-25