

General Description

OST60N65HEVF uses advanced Oriental-Semi's patented Trident-Gate Bipolar Transistor (TGBT™) technology to provide extremely low $V_{CE(sat)}$, low gate charge, and excellent switching performance. This device is suitable for mid to high range switching frequency converters.

Features

- Advanced TGBT™ technology
- Excellent conduction and switching loss
- Excellent stability and uniformity
- Fast and soft antiparallel diode



Applications

- PV inverters
- Induction converters
- Uninterruptible power supplies

Key Performance Parameters

Parameter	Value	Unit
$V_{CES, min}$ @ 25°C	650	V
Maximum junction temperature	175	°C
$I_C, pulse$	240	A
$V_{CE(sat), typ}$ @ $V_{GE}=15V$	1.5	V
Q_g	124	nC

Marking Information

Product Name	Package	Marking
OST60N65HEVF	TO247	OST60N65HEV

Package & Pin Information

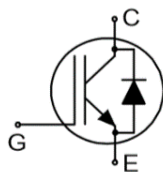

Absolute Maximum Ratings at $T_{vj}=25^{\circ}\text{C}$ unless otherwise noted

Parameter	Symbol	Value	Unit
Collector emitter voltage	V_{CES}	650	V
Gate emitter voltage	V_{GES}	± 20	V
Transient gate emitter voltage, $T_P \leq 10\mu\text{s}$, $D < 0.01$		± 30	V
Continuous collector current ¹⁾ , $T_C=25^{\circ}\text{C}$	I_C	120	A
Continuous collector current ¹⁾ , $T_C=100^{\circ}\text{C}$		60	A
Pulsed collector current ²⁾ , $T_C=25^{\circ}\text{C}$	$I_{C, pulse}$	240	A
Diode forward current ¹⁾ , $T_C=25^{\circ}\text{C}$	I_F	80	A
Diode forward current ¹⁾ , $T_C=100^{\circ}\text{C}$		60	A
Diode pulsed current ²⁾ , $T_C=25^{\circ}\text{C}$	$I_{F, pulse}$	240	A
Power dissipation ³⁾ , $T_C=25^{\circ}\text{C}$	P_D	375	W
Power dissipation ³⁾ , $T_C=100^{\circ}\text{C}$		187	W
Operation and storage temperature	T_{stg}, T_{vj}	-55 to 175	$^{\circ}\text{C}$

Thermal Characteristics

Parameter	Symbol	Value	Unit
IGBT thermal resistance, junction-case	$R_{\theta JC}$	0.4	$^{\circ}\text{C/W}$
Diode thermal resistance, junction-case	$R_{\theta JC}$	0.6	$^{\circ}\text{C/W}$
Thermal resistance, junction-ambient	$R_{\theta JA}$	40	$^{\circ}\text{C/W}$

Electrical Characteristics at $T_{vj}=25^{\circ}\text{C}$ unless otherwise specified

Parameter	Symbol	Min.	Typ.	Max.	Unit	Test condition
Collector-emitter breakdown voltage	$V_{(BR)CES}$	650			V	$V_{GE}=0\text{ V}$, $I_C=0.5\text{ mA}$
Collector-emitter saturation voltage	$V_{CE(sat)}$		1.5	1.7	V	$V_{GE}=15\text{ V}$, $I_C=60\text{ A}$ $T_{vj}=25^{\circ}\text{C}$
			1.71		V	$V_{GE}=15\text{ V}$, $I_C=60\text{ A}$, $T_{vj}=125^{\circ}\text{C}$
			1.85		V	$V_{GE}=15\text{ V}$, $I_C=60\text{ A}$, $T_{vj}=175^{\circ}\text{C}$
Gate-emitter threshold voltage	$V_{GE(th)}$	3.0	4.0	5.0	V	$V_{CE}=V_{GE}$, $I_D=0.5\text{ mA}$
Diode forward voltage	V_F		1.4	1.7	V	$V_{GE}=0\text{ V}$, $I_F=60\text{ A}$ $T_{vj}=25^{\circ}\text{C}$
			1.24		V	$V_{GE}=0\text{ V}$, $I_F=60\text{ A}$, $T_{vj}=125^{\circ}\text{C}$
			1.18		V	$V_{GE}=0\text{ V}$, $I_F=60\text{ A}$, $T_{vj}=175^{\circ}\text{C}$
Gate-emitter leakage current	I_{GES}			100	nA	$V_{CE}=0\text{ V}$, $V_{GE}=20\text{ V}$
Zero gate voltage collector current	I_{CES}			10	μA	$V_{CE}=650\text{ V}$, $V_{GE}=0\text{ V}$

Dynamic Characteristics

Parameter	Symbol	Min.	Typ.	Max.	Unit	Test condition
Input capacitance	C_{ies}		5342		pF	$V_{GE}=0\text{ V}$, $V_{CE}=25\text{ V}$, $f=100\text{ kHz}$
Output capacitance	C_{oes}		191		pF	
Reverse transfer capacitance	C_{res}		36		pF	
Turn-on delay time	$t_{d(on)}$		34		ns	$V_{GE}=15\text{ V}$, $V_{CC}=400\text{ V}$, $R_G=10\ \Omega$, $I_C=60\text{ A}$
Rise time	t_r		44		ns	
Turn-off delay time	$t_{d(off)}$		153		ns	
Fall time	t_f		38		ns	
Turn-on energy	E_{on}		1.10		mJ	
Turn-off energy	E_{off}		0.81		mJ	
Turn-on delay time	$t_{d(on)}$		31		ns	$V_{GE}=15\text{ V}$, $V_{CC}=400\text{ V}$, $R_G=10\ \Omega$, $I_C=30\text{ A}$
Rise time	t_r		20		ns	
Turn-off delay time	$t_{d(off)}$		165		ns	
Fall time	t_f		19		ns	
Turn-on energy	E_{on}		0.38		mJ	
Turn-off energy	E_{off}		0.33		mJ	

Gate Charge Characteristics

Parameter	Symbol	Min.	Typ.	Max.	Unit	Test condition
Total gate charge	Q_g		124		nC	$V_{GE}=15\text{ V}$, $V_{CC}=520\text{ V}$, $I_C=60\text{ A}$
Gate-emitter charge	Q_{ge}		38		nC	
Gate-collector charge	Q_{gc}		46		nC	

Body Diode Characteristics

Parameter	Symbol	Min.	Typ.	Max.	Unit	Test condition
Diode reverse recovery time	t_{rr}		112		ns	$V_R=400\text{ V}$, $I_F=60\text{ A}$, $di_F/dt=500\text{ A}/\mu\text{s}$ $T_{vj} = 25^\circ\text{C}$
Diode reverse recovery charge	Q_{rr}		1.22		μC	
Diode peak reverse recovery current	I_{rrm}		16.1		A	

Note

- 1) Calculated continuous current based on maximum allowable junction temperature.
- 2) Repetitive rating; pulse width limited by max. junction temperature.
- 3) P_d is based on max. junction temperature, using junction-case thermal resistance.

Electrical Characteristics Diagrams

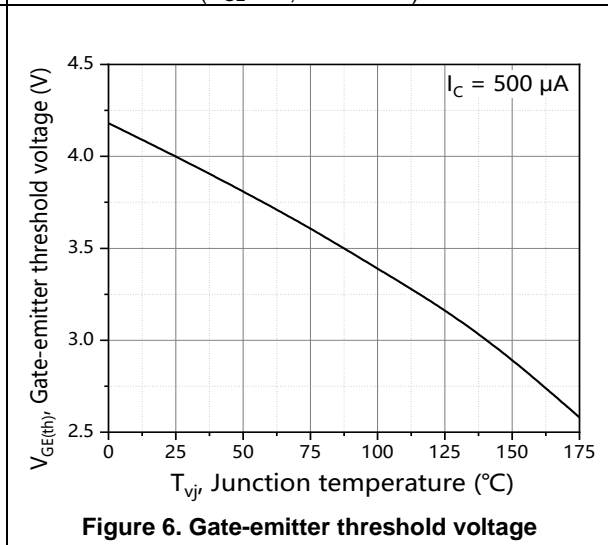
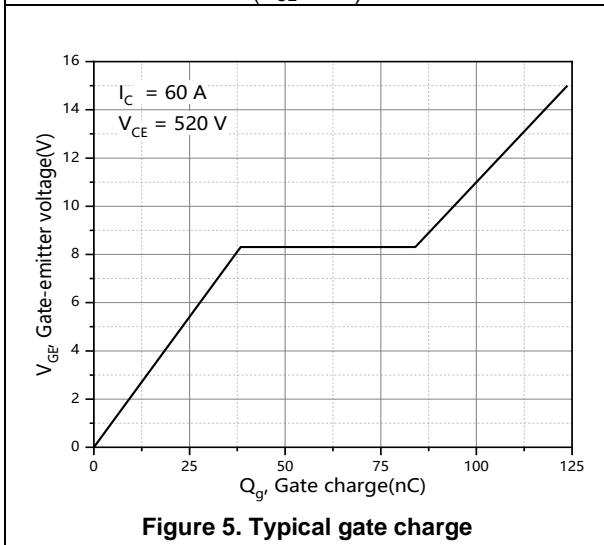
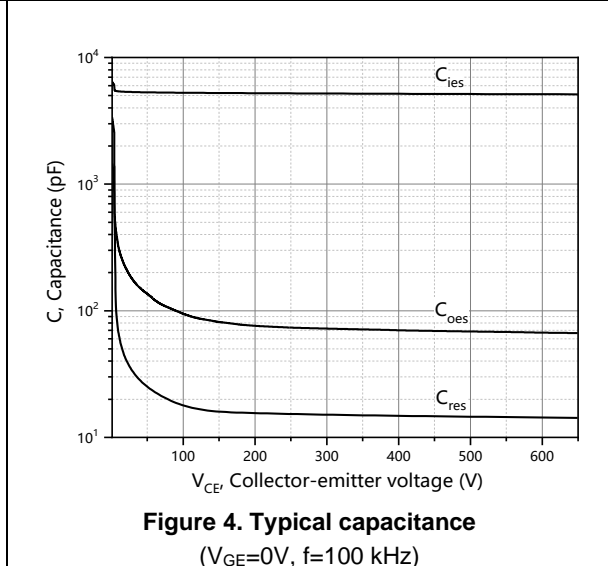
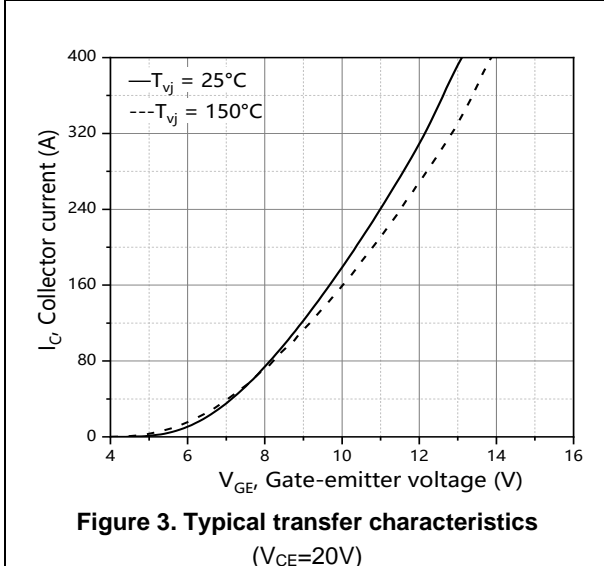
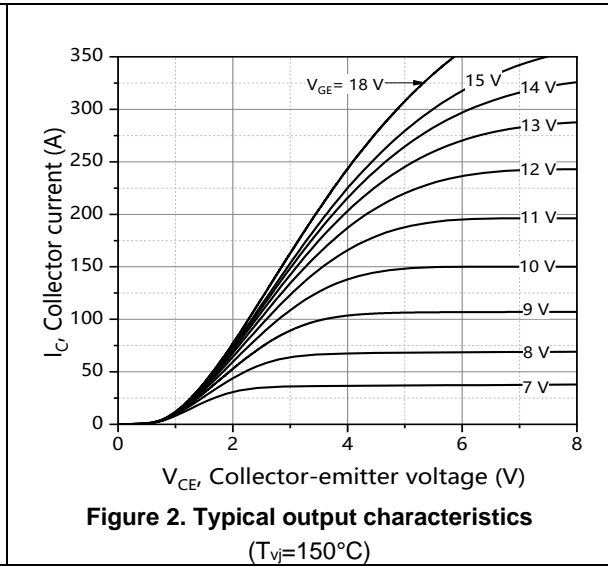
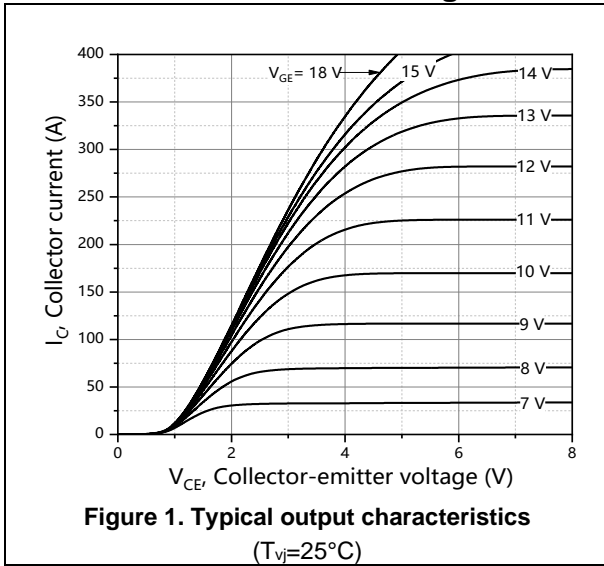

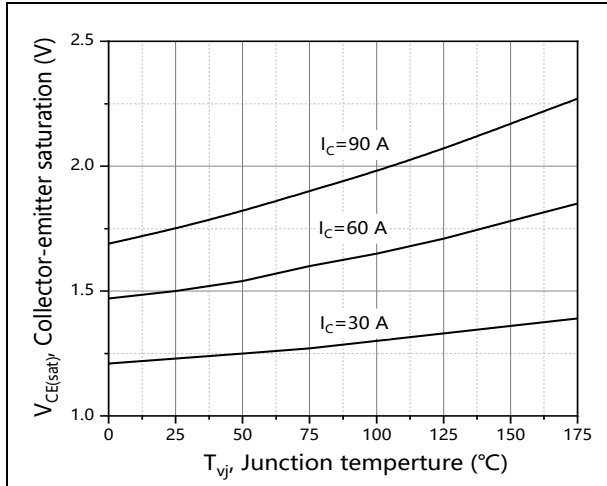

Figure 7. Typical collector-emitter voltage

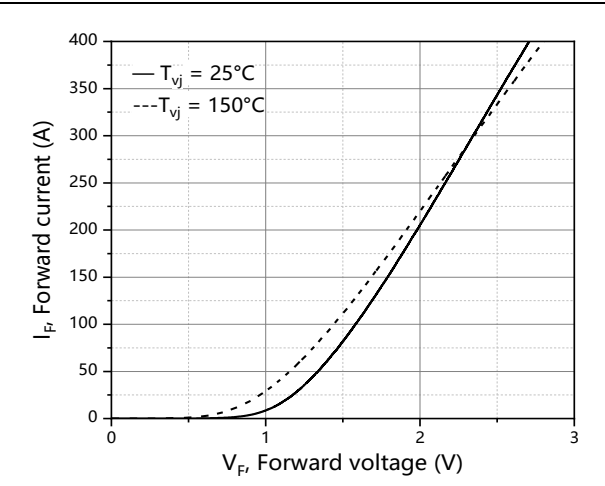

Figure 8. Forward characteristic of diode

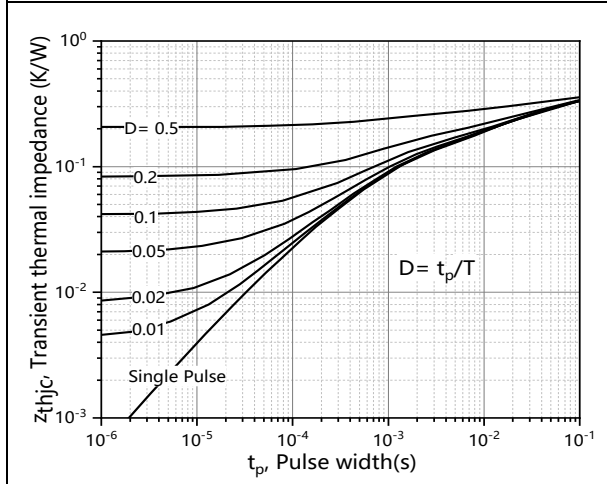

Figure 9. IGBT transient thermal impedance

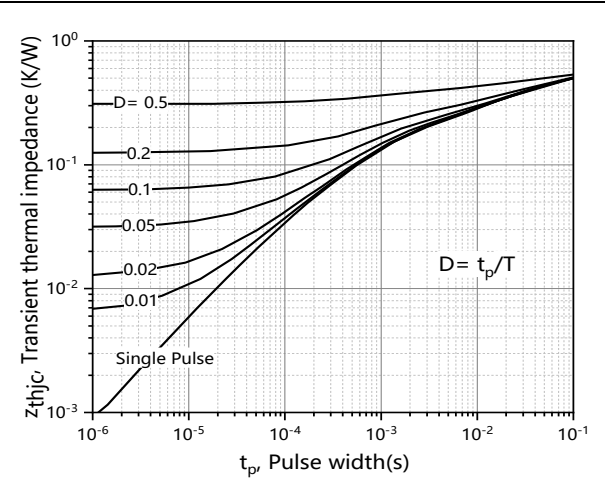

Figure 10. Diode transient thermal impedance

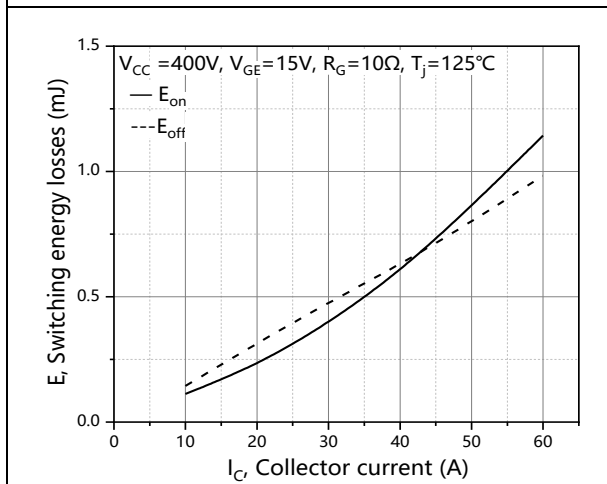
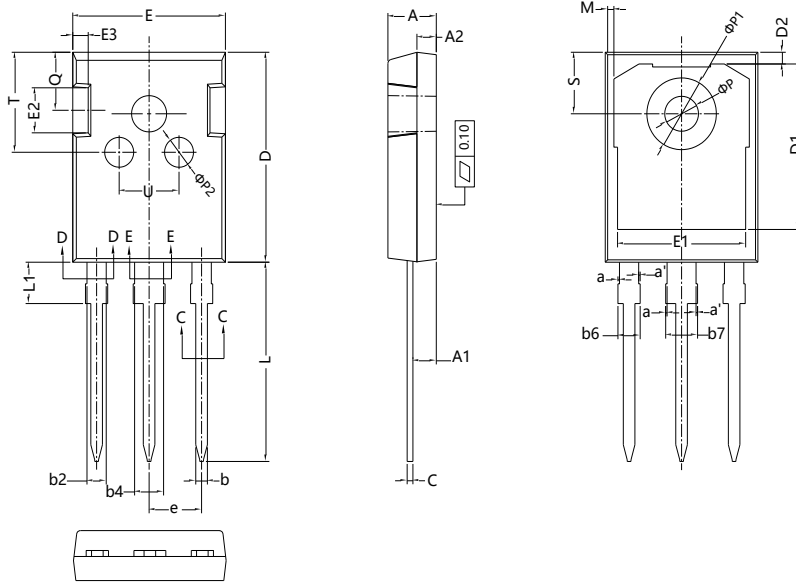

Figure 11. Switching energy vs. collector current

Package Information



Symbol	mm		
	Min	Nom	Max
A	4.90	5.00	5.10
A1	2.31	2.41	2.51
A2	1.90	2.00	2.10
a	0.00	-	0.15
a'	0.00	-	0.15
b	1.16	-	1.26
b2	1.96	-	2.06
b4	2.96	-	3.06
b6	-	-	2.25
b7	-	-	3.25
c	0.59	-	0.66
D	20.90	21.00	21.10
D1	16.25	16.55	16.85
D2	1.05	1.17	1.35
E	15.70	15.80	15.90
E1	13.10	13.30	13.50
E2	4.40	4.50	4.60
E3	1.50	1.60	1.70
e	5.436 BSC		
L	19.80	19.92	20.10
L1	-	-	4.30
M	0.35	-	0.95
P	3.40	3.50	3.60
P1	7.00	-	7.40
P2	2.40	2.5	2.6
Q	5.60	-	6.0
S	6.05	6.15	6.25
T	9.8	-	10.20
U	6.00	-	6.40

Version 1: TO247-J package outline dimension

Ordering Information

Package Type	Units/ Tube	Tubes/ Inner Box	Units/ Inner Box	Inner Boxes/ Carton Box	Units/ Carton Box
TO247-J	30	20	600	4	2400

Product Information

Product	Package	Pb Free	RoHS	Halogen Free
OST60N65HEVF	TO247	yes	yes	yes

Legal Disclaimer

The information given in this document shall in no event be regarded as a guarantee of conditions or characteristics. With respect to any examples or hints given herein, any typical values stated herein and/or any information regarding the application of the device, Oriental Semiconductor hereby disclaims any and all warranties and liabilities of any kind, including without limitation, warranties of non-infringement of intellectual property rights of any third party.

For further information on technology, delivery terms and conditions and prices, please contact the Oriental Semiconductor sales representatives (www.orientalsemi.com).

© Oriental Semiconductor Co.,Ltd. All Rights Reserved 