

## General Description

FSMOS<sup>®</sup> MOSFET is based on Oriental Semiconductor's unique device design to achieve low  $R_{DS(ON)}$ , low gate charge, fast switching and excellent avalanche characteristics. The high  $V_{th}$  series is specially designed to use in motor control systems with driving voltage of more than 10V.

## Features

- Low  $R_{DS(ON)}$  & FOM
- Extremely low switching loss
- Excellent reliability and uniformity
- Fast switching and soft recovery
- AEC-Q101 Qualified for Automotive Application



## Applications

- PD charger
- Motor driver
- Switching voltage regulator
- DC-DC convertor
- Switching mode power supply

## Key Performance Parameters

Parameter	Value	Unit
$V_{DS}$	100	V
$I_D$ , pulse	800	A
$R_{DS(ON)}$ , max @ $V_{GS}=10V$	2.3	m $\Omega$
$Q_g$	107	nC

## Marking Information

Product Name	Package	Marking
SFS10R021PNAF	TO220	SFS10R021PNA

## Package & Pin information

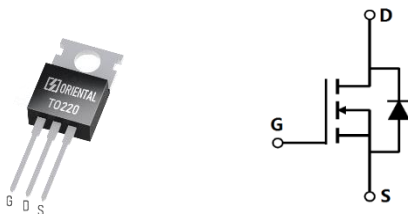

**Absolute Maximum Ratings** at  $T_j=25^\circ\text{C}$  unless otherwise noted

Parameter	Symbol	Value	Unit
Drain-source voltage	$V_{DS}$	100	V
Gate-source voltage	$V_{GS}$	$\pm 20$	V
Continuous drain current <sup>1)</sup> , $T_C=25^\circ\text{C}$	$I_D$	270	A
Pulsed drain current <sup>2)</sup> , $T_C=25^\circ\text{C}$	$I_{D, pulse}$	800	A
Continuous diode forward current <sup>1)</sup> , $T_C=25^\circ\text{C}$	$I_S$	270	A
Diode pulsed current <sup>2)</sup> , $T_C=25^\circ\text{C}$	$I_{S, pulse}$	800	A
Power dissipation <sup>3)</sup> , $T_C=25^\circ\text{C}$	$P_D$	250	W
Single pulsed avalanche energy <sup>4)</sup>	$E_{AS}$	504	mJ
Operation and storage temperature	$T_{stg}, T_j$	-55 to 175	$^\circ\text{C}$

**Thermal Characteristics**

Parameter	Symbol	Value	Unit
Thermal resistance, junction-case	$R_{\theta JC}$	0.6	$^\circ\text{C/W}$
Thermal resistance, junction-ambient	$R_{\theta JA}$	62	$^\circ\text{C/W}$

**Electrical Characteristics** at  $T_j=25^\circ\text{C}$  unless otherwise specified

Parameter	Symbol	Min.	Typ.	Max.	Unit	Test condition
Drain-source breakdown voltage	$BV_{DSS}$	100			V	$V_{GS}=0\text{ V}, I_D=250\ \mu\text{A}$
Gate threshold voltage	$V_{GS(th)}$	2		4	V	$V_{DS}=V_{GS}, I_D=250\ \mu\text{A}$
Drain-source on-state resistance	$R_{DS(ON)}$		2	2.3	m $\Omega$	$V_{GS}=10\text{ V}, I_D=50\text{ A}$
Gate-source leakage current	$I_{GSS}$			100	nA	$V_{GS}=20\text{ V}$
				-100		$V_{GS}=-20\text{ V}$
Drain-source leakage current	$I_{DSS}$			1	$\mu\text{A}$	$V_{DS}=100\text{ V}, V_{GS}=0\text{ V}$
Gate resistance	$R_G$		0.9		$\Omega$	$f=1\text{ MHz}$ , Open drain

### Dynamic Characteristics

Parameter	Symbol	Min.	Typ.	Max.	Unit	Test condition
Input capacitance	$C_{iss}$		7790		pF	$V_{GS}=0\text{ V}$ , $V_{DS}=25\text{ V}$ , $f=100\text{ kHz}$
Output capacitance	$C_{oss}$		4230		pF	
Reverse transfer capacitance	$C_{rss}$		250		pF	
Turn-on delay time	$t_{d(on)}$		27		ns	$V_{GS}=10\text{ V}$ , $V_{DS}=50\text{ V}$ , $R_G=2\ \Omega$ , $I_D=25\text{ A}$
Rise time	$t_r$		22		ns	
Turn-off delay time	$t_{d(off)}$		51		ns	
Fall time	$t_f$		20		ns	

### Gate Charge Characteristics

Parameter	Symbol	Min.	Typ.	Max.	Unit	Test condition
Total gate charge	$Q_g$		106		nC	$V_{GS}=10\text{ V}$ , $V_{DS}=50\text{ V}$ , $I_D=25\text{ A}$
Gate-source charge	$Q_{gs}$		30		nC	
Gate-drain charge	$Q_{gd}$		23		nC	
Gate plateau voltage	$V_{plateau}$		4.4		V	

### Body Diode Characteristics

Parameter	Symbol	Min.	Typ.	Max.	Unit	Test condition
Diode forward voltage	$V_{SD}$			1.3	V	$I_S=20\text{ A}$ , $V_{GS}=0\text{ V}$
Reverse recovery time	$t_{rr}$		136		ns	$V_R=50\text{ V}$ , $I_S=25\text{ A}$ , $di/dt=100\text{ A}/\mu\text{s}$
Reverse recovery charge	$Q_{rr}$		219		nC	
Peak reverse recovery current	$I_{rrm}$		2.9		A	

#### Note

- 1) Calculated continuous current based on maximum allowable junction temperature.
- 2) Repetitive rating; pulse width limited by max. junction temperature.
- 3)  $P_d$  is based on max. junction temperature, using junction-case thermal resistance.
- 4)  $V_{DD}=50\text{ V}$ ,  $V_{GS}=10\text{ V}$ ,  $L=0.3\text{ mH}$ , starting  $T_j=25\text{ }^\circ\text{C}$ .

**Electrical Characteristics Diagrams**

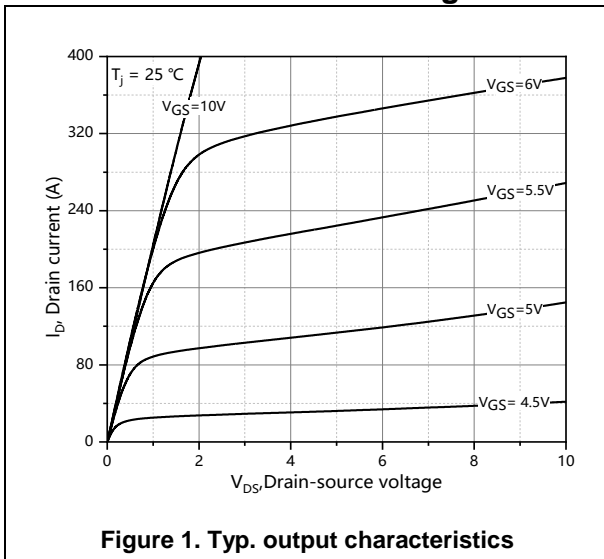

**Figure 1. Typ. output characteristics**

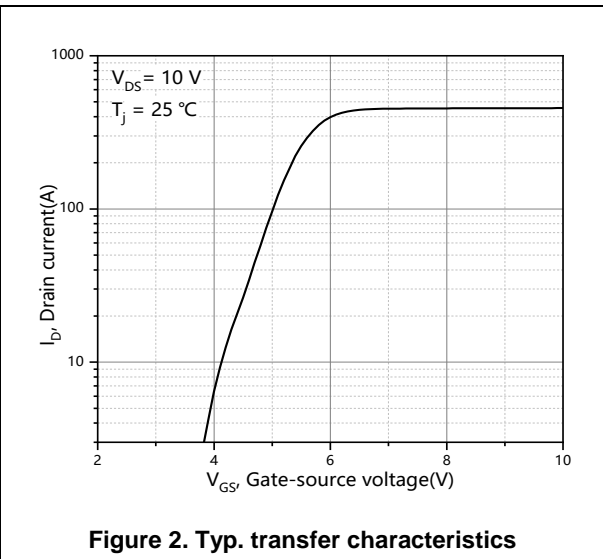

**Figure 2. Typ. transfer characteristics**

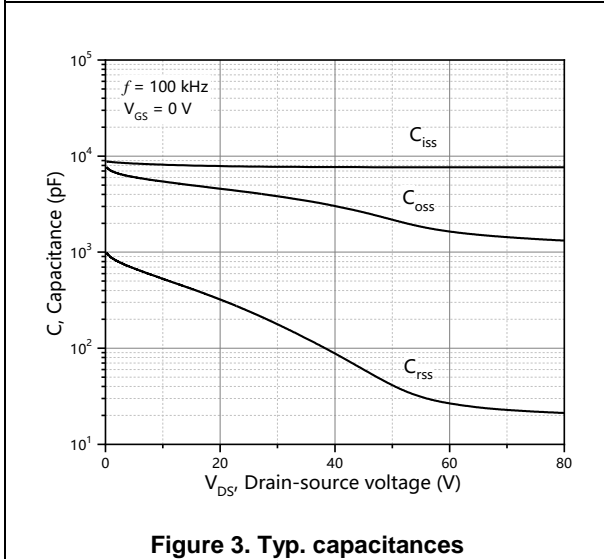

**Figure 3. Typ. capacitances**

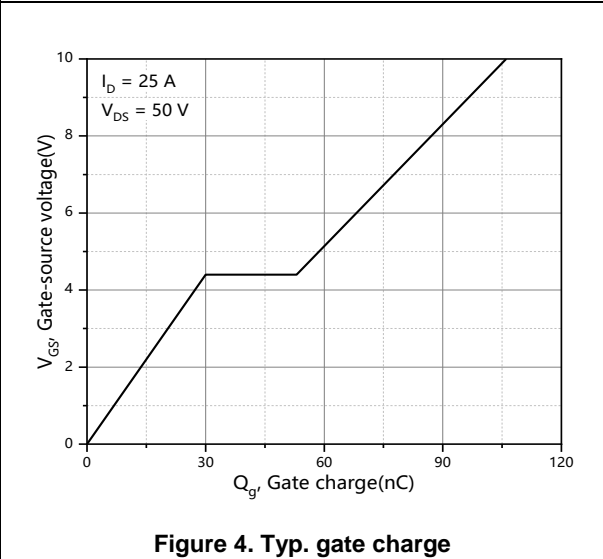

**Figure 4. Typ. gate charge**

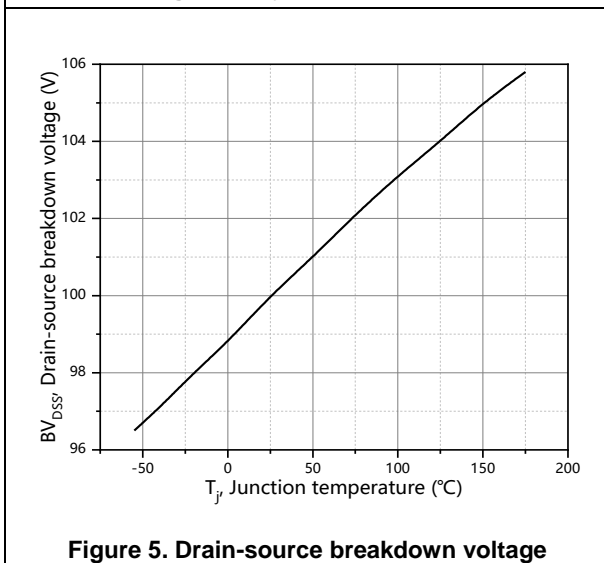

**Figure 5. Drain-source breakdown voltage**

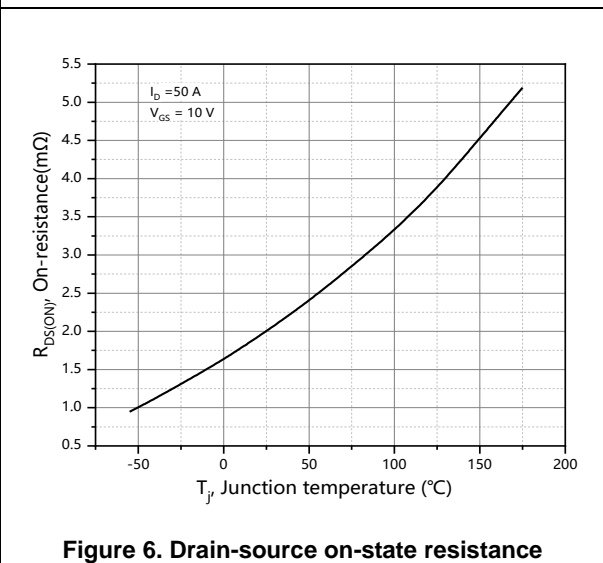

**Figure 6. Drain-source on-state resistance**

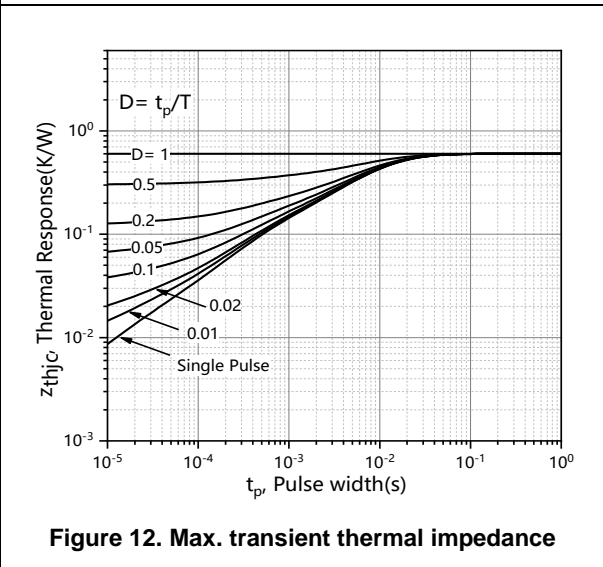
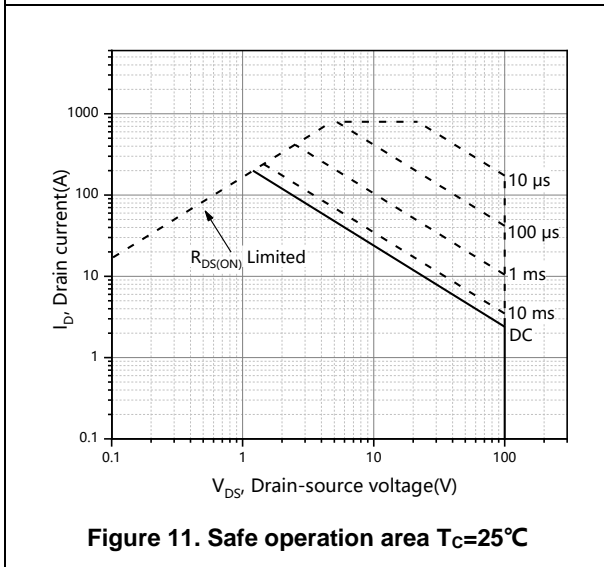
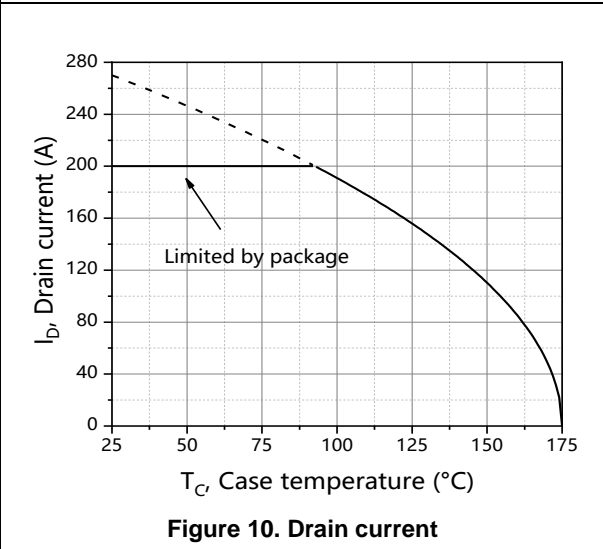
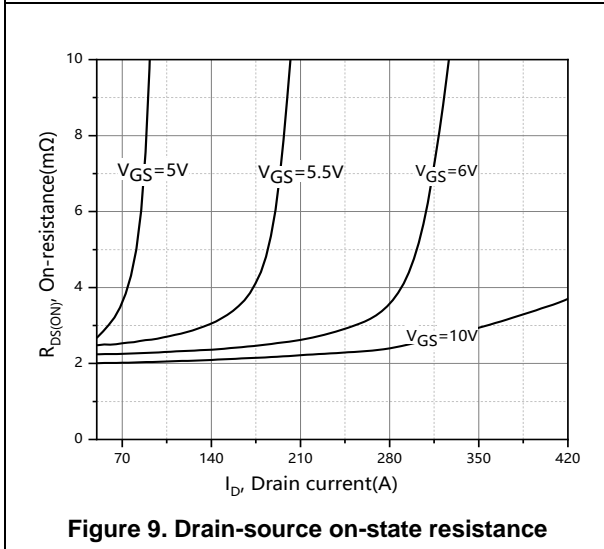
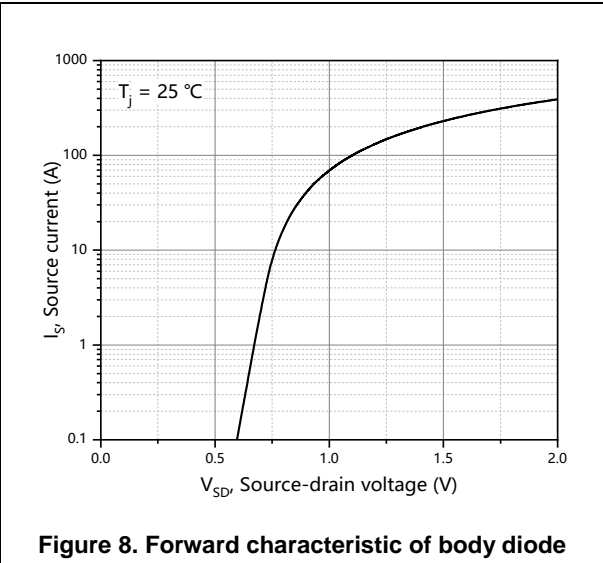
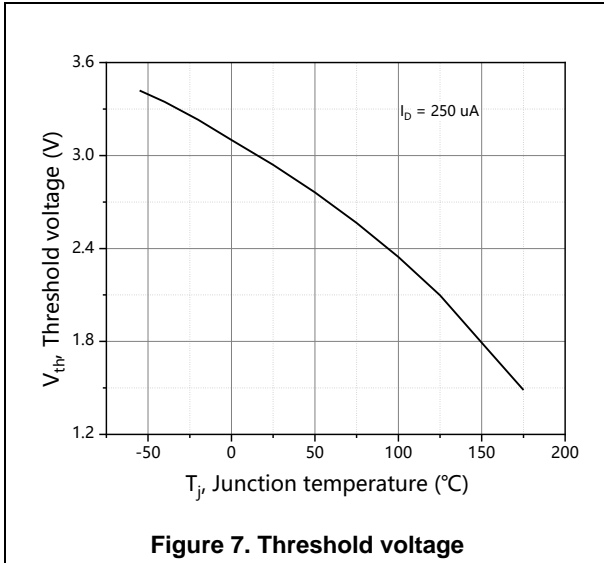

**Test circuits and waveforms**



**Figure 1. Gate charge test circuit & waveform**



**Figure 2. Switching time test circuit & waveforms**

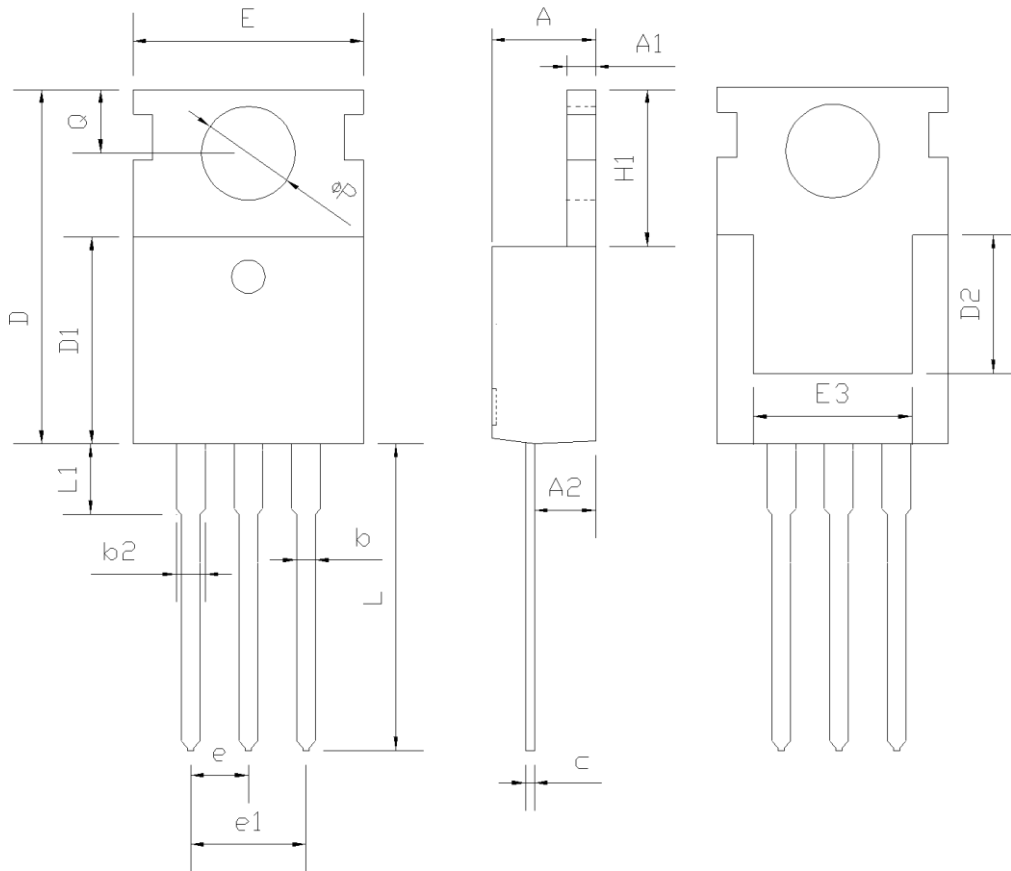

**Figure 3. Unclamped inductive switching (UIS) test circuit & waveforms**



**Figure 4. Diode reverse recovery test circuit & waveforms**

**Package Information**



Symbol	mm		
	Min	Nom	Max
A	4.37	4.57	4.77
A1	1.25	1.30	1.45
A2	2.20	2.40	2.60
b	0.70	0.80	0.95
b2	1.17	1.27	1.47
c	0.40	0.50	0.65
D	15.10	15.60	16.10
D1	8.80	9.10	9.40
D2	5.50	-	-
E	9.70	10.00	10.30
E3	7.00	-	-
e	2.54 BSC		
e1	5.08 BSC		
H1	6.25	6.50	6.85
L	12.75	13.50	13.80
L1	-	3.10	3.40
ΦP	3.40	3.60	3.80
Q	2.60	2.80	3.00

Version 1: TO220-P package outline dimension

## Ordering Information

Package Type	Units/ Reel	Reels / Inner Box	Units/ Inner Box	Inner Boxes/ Carton Box	Units/ Carton Box
TO220-P	50	20	1000	6	6000

## Product Information

Product	Package	Pb Free	RoHS	Halogen Free
SFS10R021PNAF	TO220	yes	yes	yes

## Legal Disclaimer

The information given in this document shall in no event be regarded as a guarantee of conditions or characteristics. With respect to any examples or hints given herein, any typical values stated herein and/or any information regarding the application of the device, Oriental Semiconductor hereby disclaims any and all warranties and liabilities of any kind, including without limitation, warranties of non-infringement of intellectual property rights of any third party.

For further information on technology, delivery terms and conditions and prices, please contact the Oriental Semiconductor sales representatives ([www.orientalsemi.com](http://www.orientalsemi.com)).

© Oriental Semiconductor Co.,Ltd. All Rights Reserved 