

## General Description

FSMOS<sup>®</sup> MOSFET is based on Oriental Semiconductor's unique device design to achieve low  $R_{DS(ON)}$ , low gate charge, fast switching and excellent avalanche characteristics. The low  $V_{th}$  series is specially optimized for synchronous rectification systems with low driving voltage.

## Features

- Low  $R_{DS(ON)}$  & FOM
- Extremely low switching loss
- Excellent reliability and uniformity
- Fast switching and soft recovery



## Applications

- PD charger
- Motor driver
- Switching voltage regulator
- DC-DC convertor
- Switched mode power supply

## Key Performance Parameters

Parameter	Value	Unit
$V_{DS, min} @ T_{j(max)}$	100	V
$I_{D, pulse}$	560	A
$R_{DS(ON), max} @ V_{GS}=10V$	4.5	m $\Omega$
$Q_g$	69.3	nC

## Marking Information

Product Name	Package	Marking
SFS10R04GF	PDFN5×6	SFS10R04G

## Package & Pin information

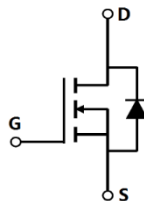

**Absolute Maximum Ratings** at  $T_j=25^{\circ}\text{C}$  unless otherwise noted

Parameter	Symbol	Value	Unit
Drain-source voltage	$V_{DS}$	100	V
Gate-source voltage	$V_{GS}$	$\pm 20$	V
Continuous drain current <sup>1)</sup> , $T_C=25^{\circ}\text{C}$	$I_D$	140	A
Pulsed drain current <sup>2)</sup> , $T_C=25^{\circ}\text{C}$	$I_{D, pulse}$	560	A
Continuous diode forward current <sup>1)</sup> , $T_C=25^{\circ}\text{C}$	$I_S$	140	A
Diode pulsed current <sup>2)</sup> , $T_C=25^{\circ}\text{C}$	$I_{S, pulse}$	560	A
Power dissipation <sup>3)</sup> , $T_C=25^{\circ}\text{C}$	$P_D$	170	W
Single pulsed avalanche energy <sup>5)</sup>	$E_{AS}$	26.4	mJ
Operation and storage temperature	$T_{stg}, T_j$	-55 to 150	$^{\circ}\text{C}$

**Thermal Characteristics**

Parameter	Symbol	Value	Unit
Thermal resistance, junction-case	$R_{\theta JC}$	0.73	$^{\circ}\text{C/W}$
Thermal resistance, junction-ambient <sup>4)</sup>	$R_{\theta JA}$	62	$^{\circ}\text{C/W}$

**Electrical Characteristics** at  $T_j=25^{\circ}\text{C}$  unless otherwise specified

Parameter	Symbol	Min.	Typ.	Max.	Unit	Test condition
Drain-source breakdown voltage	$BV_{DSS}$	100			V	$V_{GS}=0\text{ V}, I_D=250\ \mu\text{A}$
Gate threshold voltage	$V_{GS(th)}$	1.0		2.5	V	$V_{DS}=V_{GS}, I_D=250\ \mu\text{A}$
Drain-source on-state resistance	$R_{DS(ON)}$		3.6	4.5	m $\Omega$	$V_{GS}=10\text{ V}, I_D=50\text{ A}$
Drain-source on-state resistance	$R_{DS(ON)}$		4.4	6	m $\Omega$	$V_{GS}=4.5\text{ V}, I_D=30\text{ A}$
Gate-source leakage current	$I_{GSS}$			100	nA	$V_{GS}=20\text{ V}$
				-100		$V_{GS}=-20\text{ V}$
Drain-source leakage current	$I_{DSS}$			1	$\mu\text{A}$	$V_{DS}=100\text{ V}, V_{GS}=0\text{ V}$
Gate resistance	$R_G$		1.5		$\Omega$	$f=1\text{ MHz}$ , Open drain

### Dynamic Characteristics

Parameter	Symbol	Min.	Typ.	Max.	Unit	Test condition
Input capacitance	$C_{iss}$		4210		pF	$V_{GS}=0\text{ V}$ , $V_{DS}=25\text{ V}$ , $f=100\text{ kHz}$
Output capacitance	$C_{oss}$		2050		pF	
Reverse transfer capacitance	$C_{rss}$		149		pF	
Turn-on delay time	$t_{d(on)}$		14.8		ns	$V_{GS}=10\text{ V}$ , $V_{DS}=50\text{ V}$ , $R_G=5\ \Omega$ , $I_D=40\text{ A}$
Rise time	$t_r$		13		ns	
Turn-off delay time	$t_{d(off)}$		74		ns	
Fall time	$t_f$		28.4		ns	

### Gate Charge Characteristics

Parameter	Symbol	Min.	Typ.	Max.	Unit	Test condition
Total gate charge	$Q_g$		69.3		nC	$V_{GS}=10\text{ V}$ , $V_{DS}=50\text{ V}$ , $I_D=40\text{ A}$
Gate-source charge	$Q_{gs}$		11		nC	
Gate-drain charge	$Q_{gd}$		13.5		nC	
Gate plateau voltage	$V_{plateau}$		3		V	

### Body Diode Characteristics

Parameter	Symbol	Min.	Typ.	Max.	Unit	Test condition
Diode forward voltage	$V_{SD}$			1.3	V	$I_S=25\text{ A}$ , $V_{GS}=0\text{ V}$
Reverse recovery time	$t_{rr}$		94.8		ns	$V_R=50\text{ V}$ , $I_S=40\text{ A}$ , $di/dt=100\text{ A}/\mu\text{s}$
Reverse recovery charge	$Q_{rr}$		176		nC	
Peak reverse recovery current	$I_{rrm}$		3.4		A	

### Note

- 1) Calculated continuous current based on maximum allowable junction temperature.
- 2) Repetitive rating; pulse width limited by max. junction temperature.
- 3)  $P_d$  is based on max. junction temperature, using junction-case thermal resistance.
- 4) The value of  $R_{\theta JA}$  is measured with the device mounted on 1 in square FR-4 board with 2oz. Copper, in a still air environment with  $T_a=25\text{ }^\circ\text{C}$ .
- 5)  $V_{DD}=50\text{ V}$ ,  $V_{GS}=10\text{ V}$ ,  $L=0.3\text{ mH}$ , starting  $T_j=25\text{ }^\circ\text{C}$ .

**Electrical Characteristics Diagrams**

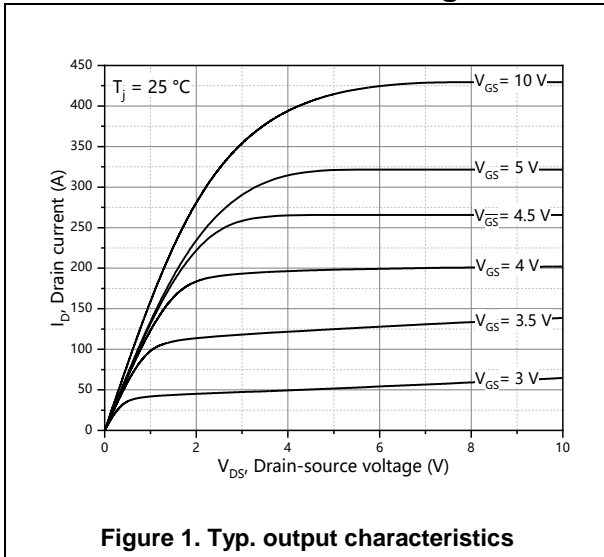

**Figure 1. Typ. output characteristics**

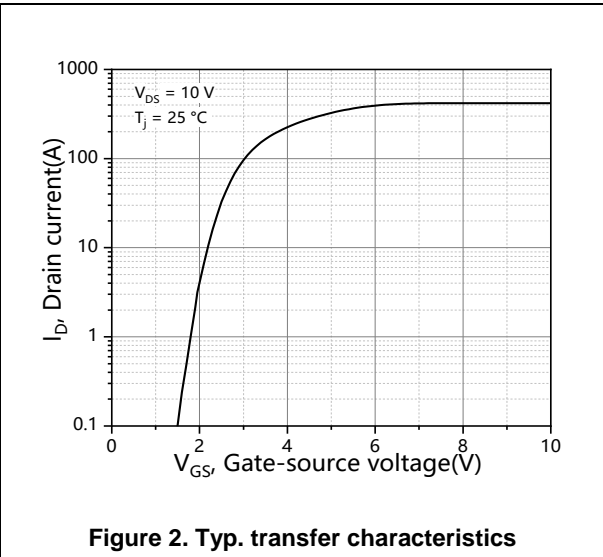

**Figure 2. Typ. transfer characteristics**

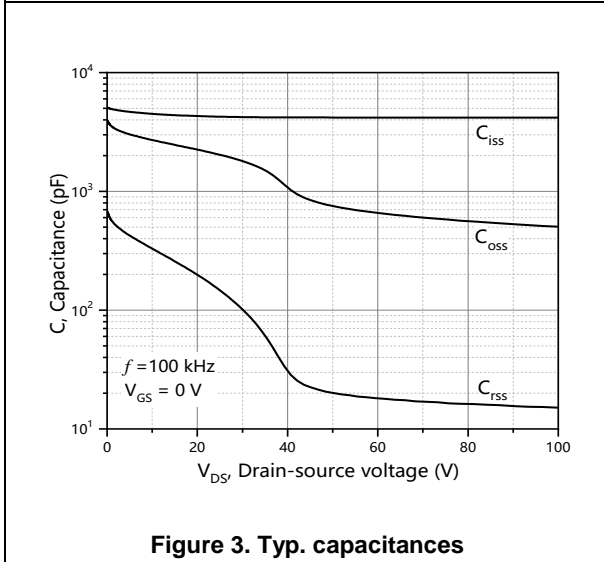

**Figure 3. Typ. capacitances**

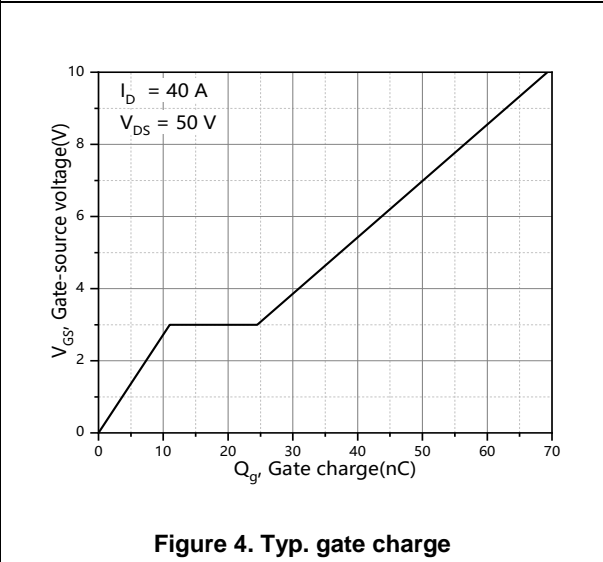

**Figure 4. Typ. gate charge**

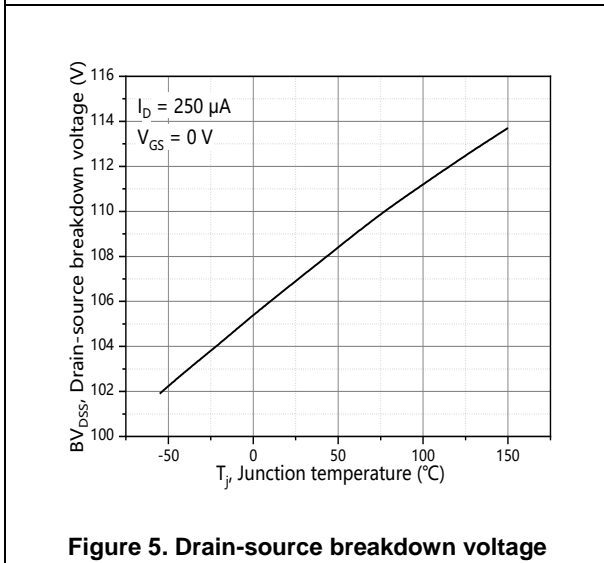

**Figure 5. Drain-source breakdown voltage**

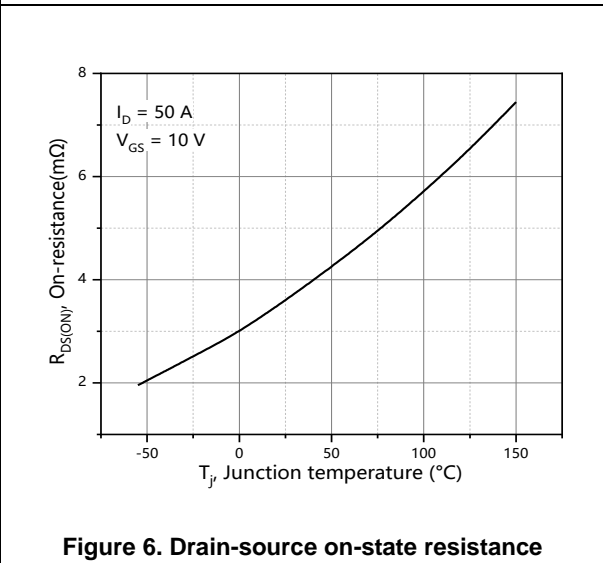

**Figure 6. Drain-source on-state resistance**

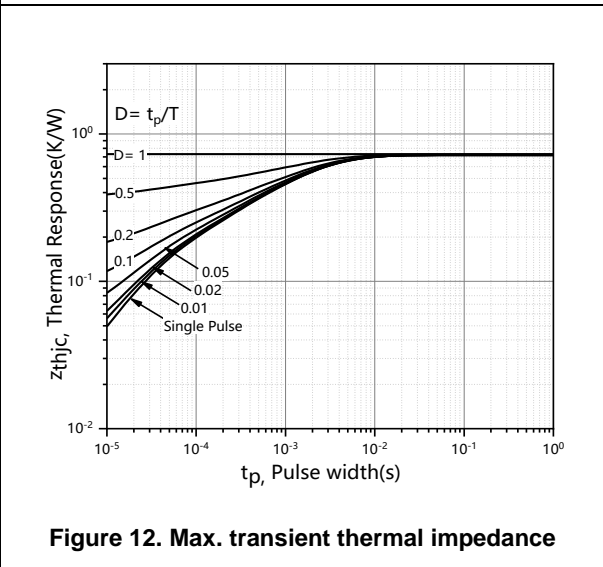
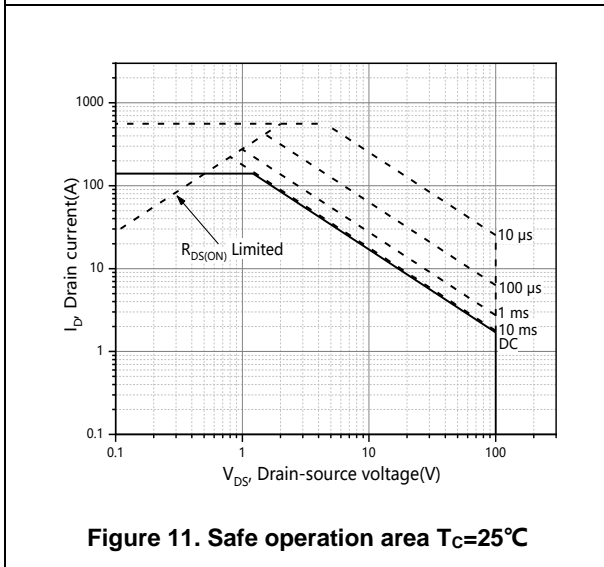
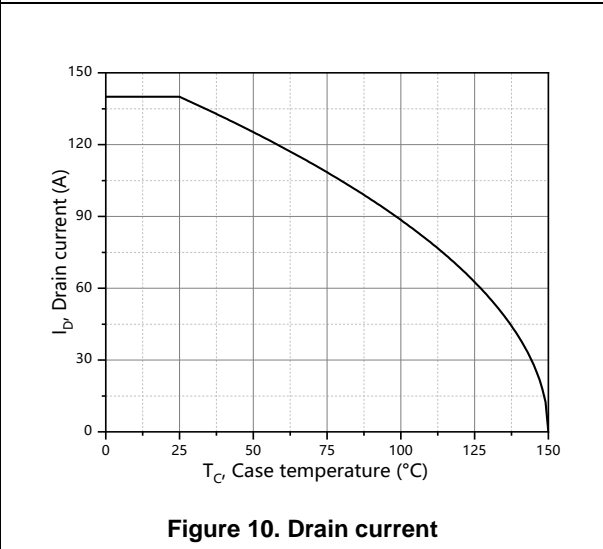
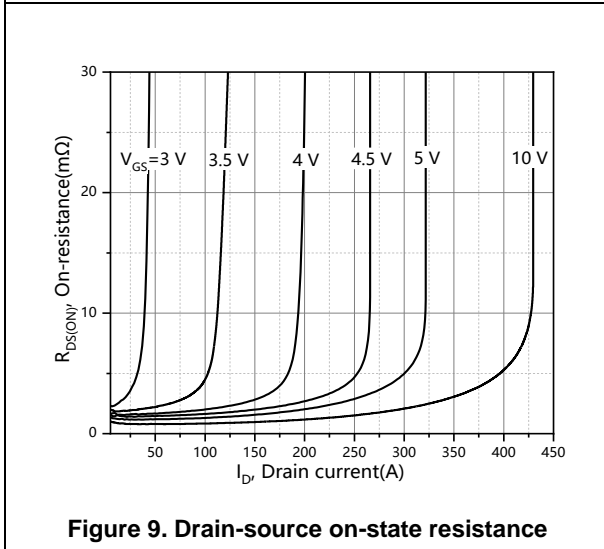
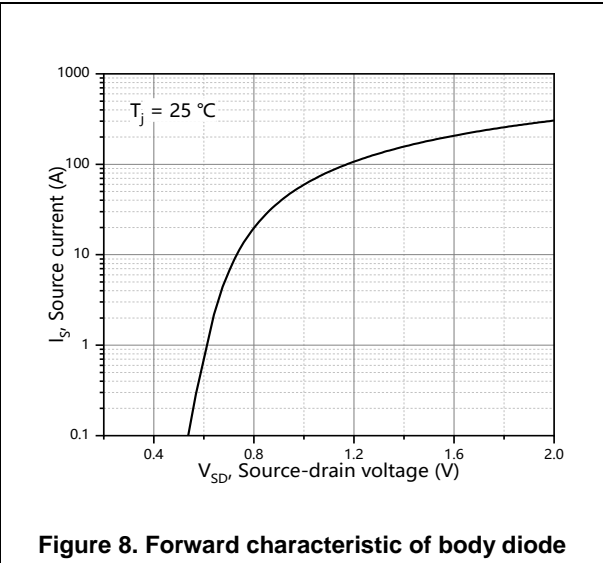
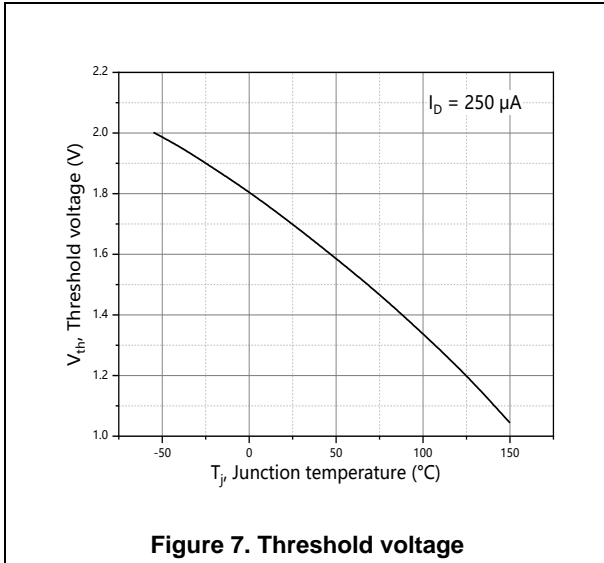

**Test circuits and waveforms**



**Figure 1. Gate charge test circuit & waveform**



**Figure 2. Switching time test circuit & waveforms**

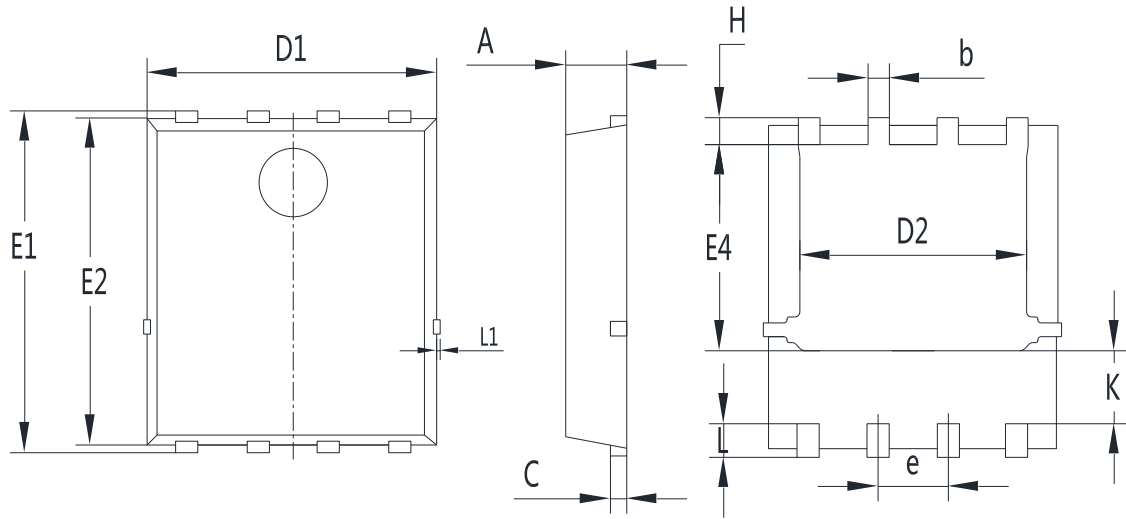

**Figure 3. Unclamped inductive switching (UIS) test circuit & waveforms**



**Figure 4. Diode reverse recovery test circuit & waveforms**

**Package Information**



Symbol	mm		
	Min	Nom	Max
A	1.00	1.10	1.20
b	0.30	0.40	0.50
c	0.154	0.254	0.354
D1	5.00	5.20	5.40
D2	3.80	4.10	4.25
e	1.17	1.27	1.37
E1	5.95	6.15	6.35
E2	5.66	5.86	6.06
E4	3.52	3.72	3.92
H	0.40	0.50	0.60
L	0.30	0.60	0.70
L1	0.12 REF		
K	1.15	1.30	1.45

Version 1: PDFN5×6-P package outline dimension

### Ordering Information

Package Type	Units/ Reel	Reels/ Inner Box	Units/ Inner Box	Inner Boxes/ Carton Box	Units/ Carton Box
PDFN5×6-P	5000	2	10000	5	50000

### Product Information

Product	Package	Pb Free	RoHS	Halogen Free
SFS10R04GF	PDFN5×6	yes	yes	yes

### Legal Disclaimer

The information given in this document shall in no event be regarded as a guarantee of conditions or characteristics. With respect to any examples or hints given herein, any typical values stated herein and/or any information regarding the application of the device, Oriental Semiconductor hereby disclaims any and all warranties and liabilities of any kind, including without limitation, warranties of non-infringement of intellectual property rights of any third party.

For further information on technology, delivery terms and conditions and prices, please contact the Oriental Semiconductor sales representatives ([www.orientalsemi.com](http://www.orientalsemi.com)).

© Oriental Semiconductor Co.,Ltd. All Rights Reserved /