

General Description

FSMOS[®] MOSFET is based on Oriental Semiconductor's unique device design to achieve low $R_{DS(ON)}$, low gate charge, fast switching and excellent avalanche characteristics. The low V_{th} series is specially optimized for synchronous rectification systems with low driving voltage.

Features

- Low $R_{DS(ON)}$ & FOM
- Extremely low switching loss
- Excellent reliability and uniformity
- Fast switching and soft recovery



Applications

- PD charger
- Motor driver
- Switching voltage regulator
- DC-DC convertor
- Switching mode power supply

Key Performance Parameters

Parameter	Value	Unit
V_{DS}	150	V
$I_D, pulse$	192	A
$R_{DS(ON), max} @ V_{GS}=10V$	20	m Ω
Q_g	21.9	nC

Marking Information

Product Name	Package	Marking
SFS15R20IF	TO262	SFS15R20I

Package & Pin information

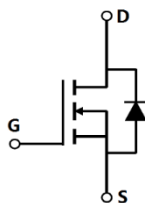

Absolute Maximum Ratings at $T_j=25^{\circ}\text{C}$ unless otherwise noted

Parameter	Symbol	Value	Unit
Drain-source voltage	V_{DS}	150	V
Gate-source voltage	V_{GS}	± 20	V
Continuous drain current ¹⁾ , $T_C=25^{\circ}\text{C}$	I_D	48	A
Pulsed drain current ²⁾ , $T_C=25^{\circ}\text{C}$	$I_{D, pulse}$	192	A
Continuous diode forward current ¹⁾ , $T_C=25^{\circ}\text{C}$	I_S	48	A
Diode pulsed current ²⁾ , $T_C=25^{\circ}\text{C}$	$I_{S, pulse}$	192	A
Power dissipation ³⁾ , $T_C=25^{\circ}\text{C}$	P_D	115	W
Single pulsed avalanche energy ⁴⁾	E_{AS}	127	mJ
Operation and storage temperature	T_{stg}, T_j	-55 to 175	$^{\circ}\text{C}$

Thermal Characteristics

Parameter	Symbol	Value	Unit
Thermal resistance, junction-case	$R_{\theta JC}$	1.3	$^{\circ}\text{C/W}$
Thermal resistance, junction-ambient	$R_{\theta JA}$	62.5	$^{\circ}\text{C/W}$

Electrical Characteristics at $T_j=25^{\circ}\text{C}$ unless otherwise specified

Parameter	Symbol	Min.	Typ.	Max.	Unit	Test condition
Drain-source breakdown voltage	BV_{DSS}	150			V	$V_{GS}=0\text{ V}, I_D=250\ \mu\text{A}$
Gate threshold voltage	$V_{GS(th)}$	1.5		3.5	V	$V_{DS}=V_{GS}, I_D=250\ \mu\text{A}$
Drain-source on-state resistance	$R_{DS(ON)}$		16.3	20	m Ω	$V_{GS}=10\text{ V}, I_D=30\text{ A}$
Drain-source on-state resistance	$R_{DS(ON)}$		18.8	25	m Ω	$V_{GS}=6\text{ V}, I_D=30\text{ A}$
Drain-source on-state resistance	$R_{DS(ON)}$		21.5	28	m Ω	$V_{GS}=5\text{ V}, I_D=30\text{ A}$
Gate-source leakage current	I_{GSS}			100	nA	$V_{GS}=20\text{ V}$
				-100		$V_{GS}=-20\text{ V}$
Drain-source leakage current	I_{DSS}			1	μA	$V_{DS}=150\text{ V}, V_{GS}=0\text{ V}$
Gate resistance	R_G		1.7		Ω	$f=1\text{ MHz}, \text{Open drain}$

Dynamic Characteristics

Parameter	Symbol	Min.	Typ.	Max.	Unit	Test condition
Input capacitance	C_{iss}		1401		pF	$V_{GS}=0\text{ V}$, $V_{DS}=80\text{ V}$, $f=100\text{ kHz}$
Output capacitance	C_{oss}		417		pF	
Reverse transfer capacitance	C_{rss}		15		pF	
Turn-on delay time	$t_{d(on)}$		14		ns	$V_{GS}=10\text{ V}$, $V_{DS}=80\text{ V}$, $R_G=2\ \Omega$, $I_D=30\text{ A}$
Rise time	t_r		22.4		ns	
Turn-off delay time	$t_{d(off)}$		22		ns	
Fall time	t_f		7.6		ns	

Gate Charge Characteristics

Parameter	Symbol	Min.	Typ.	Max.	Unit	Test condition
Total gate charge	Q_g		21.9		nC	$V_{GS}=10\text{ V}$, $V_{DS}=80\text{ V}$, $I_D=30\text{ A}$
Gate-source charge	Q_{gs}		5.6		nC	
Gate-drain charge	Q_{gd}		5.2		nC	
Gate plateau voltage	$V_{plateau}$		4.3		V	

Body Diode Characteristics

Parameter	Symbol	Min.	Typ.	Max.	Unit	Test condition
Diode forward voltage	V_{SD}			1.3	V	$I_S=30\text{ A}$, $V_{GS}=0\text{ V}$
Reverse recovery time	t_{rr}		52.2		ns	$V_R=80\text{ V}$, $I_S=30\text{ A}$, $di/dt=400\text{ A}/\mu\text{s}$
Reverse recovery charge	Q_{rr}		229		nC	
Peak reverse recovery current	I_{rrm}		7.7		A	

Note

- 1) Calculated continuous current based on maximum allowable junction temperature.
- 2) Repetitive rating; pulse width limited by max. junction temperature.
- 3) P_d is based on max. junction temperature, using junction-case thermal resistance.
- 4) $V_{DD}=50\text{ V}$, $V_{GS}=10\text{ V}$, $L=0.3\text{ mH}$, starting $T_j=25\text{ }^\circ\text{C}$.

Electrical Characteristics Diagrams

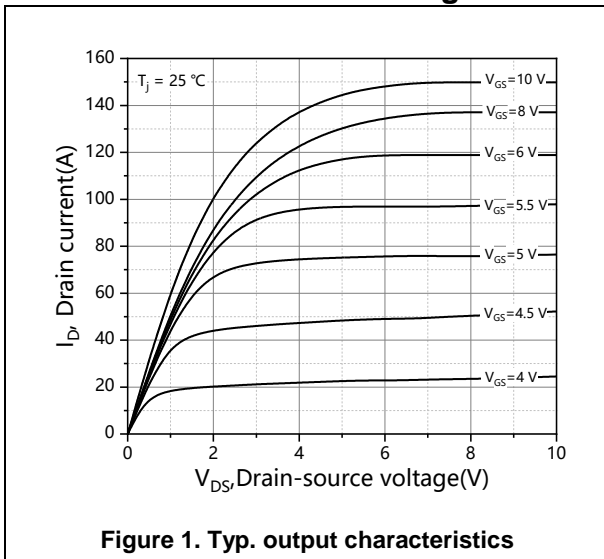

Figure 1. Typ. output characteristics

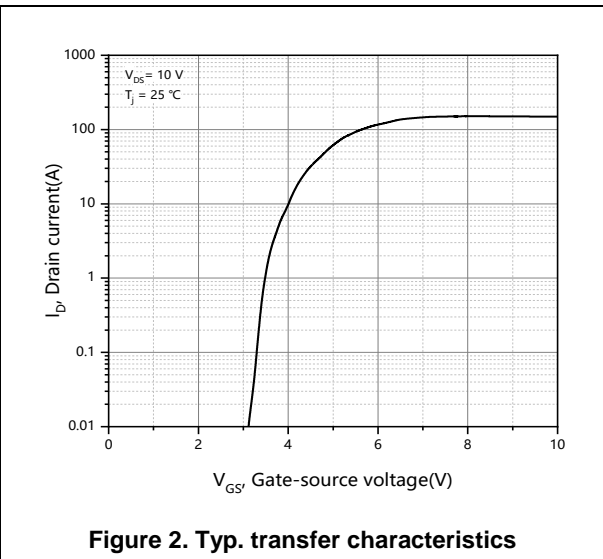

Figure 2. Typ. transfer characteristics

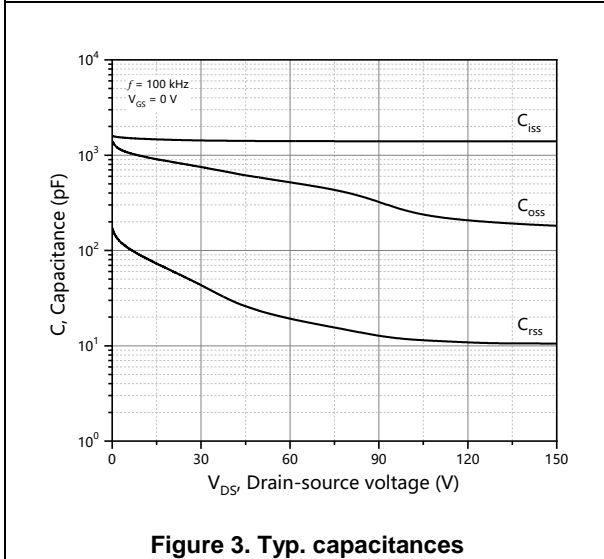

Figure 3. Typ. capacitances

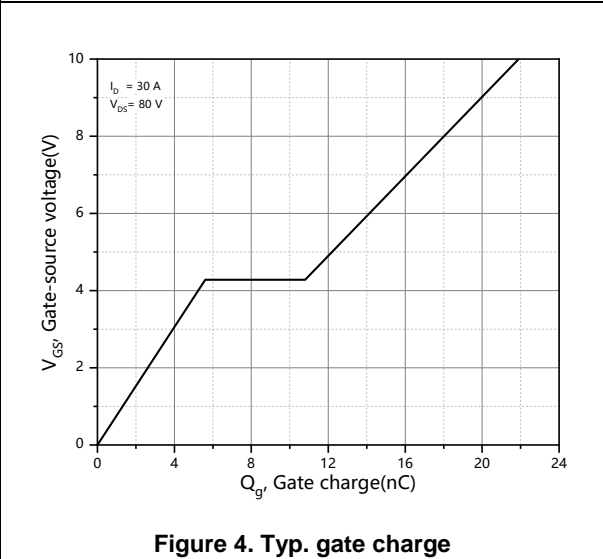

Figure 4. Typ. gate charge

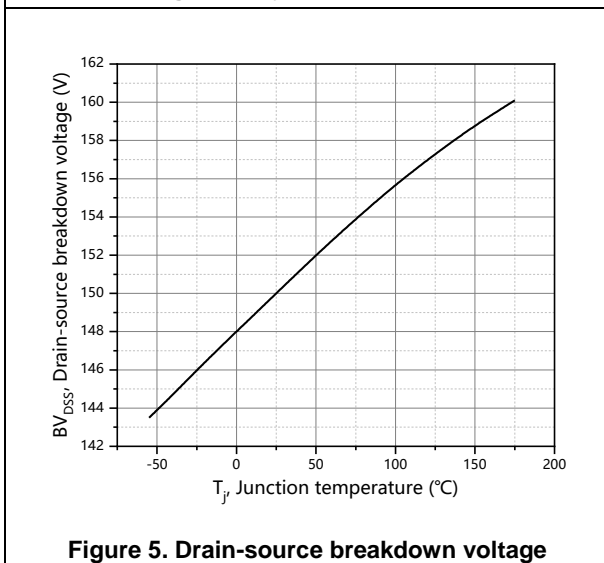

Figure 5. Drain-source breakdown voltage

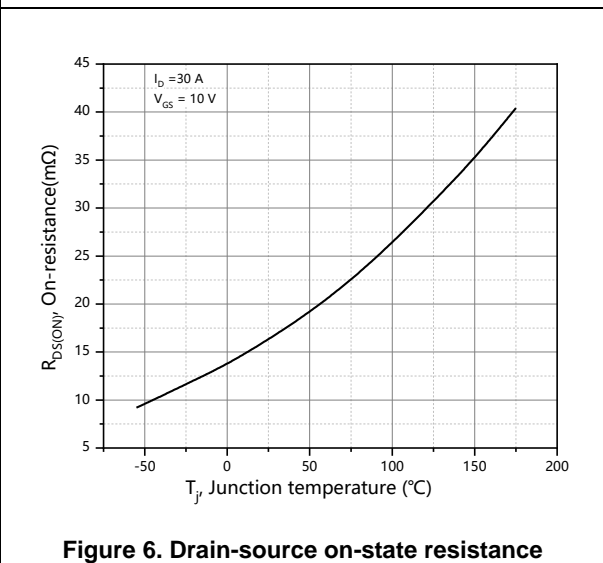
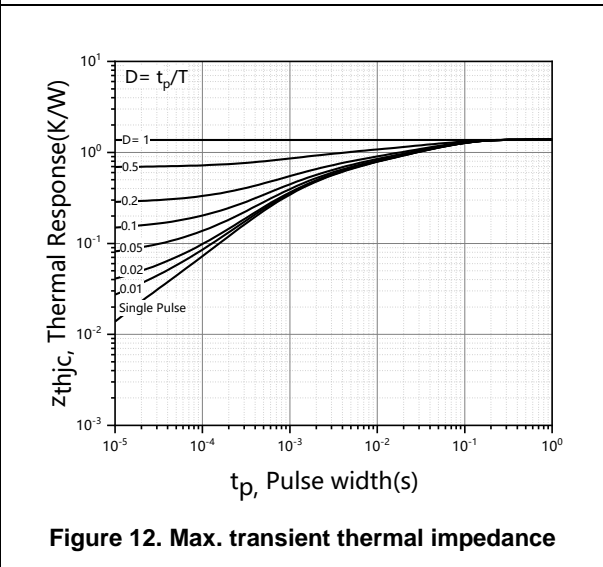
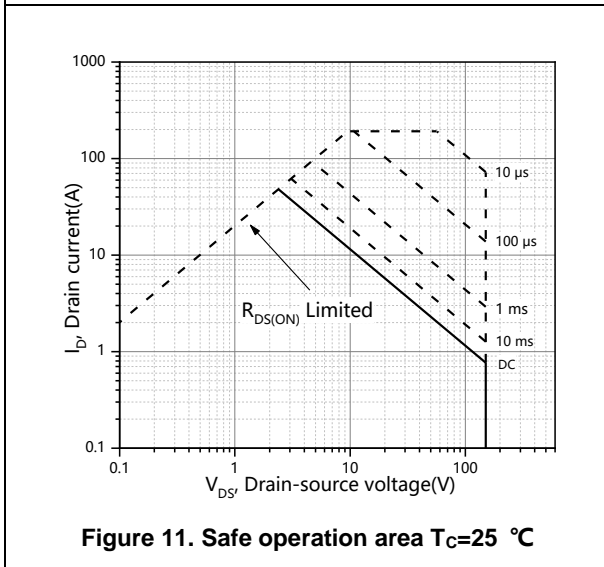
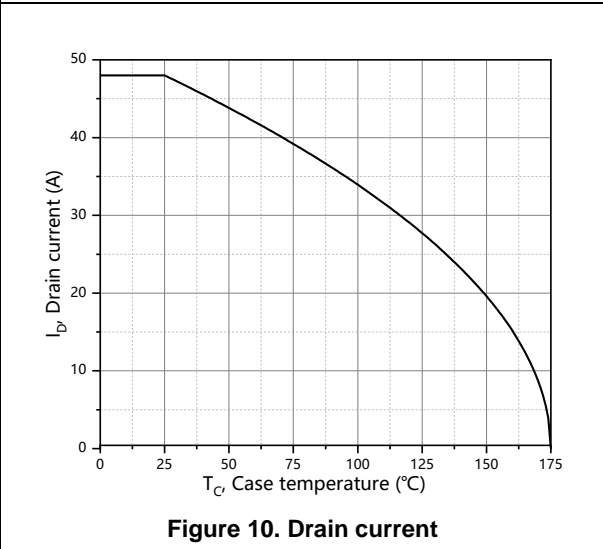
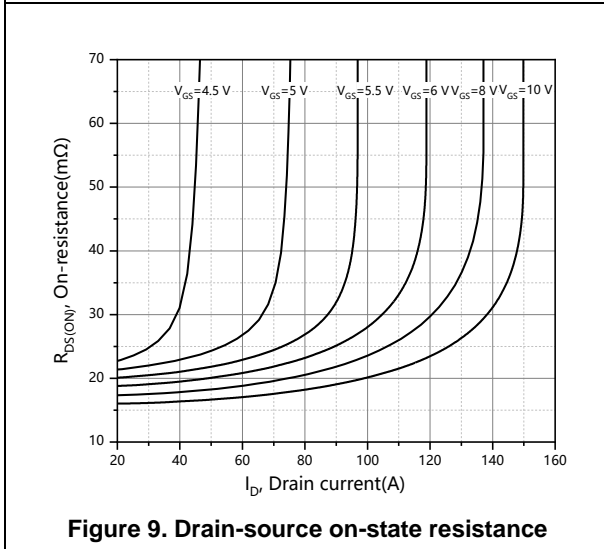
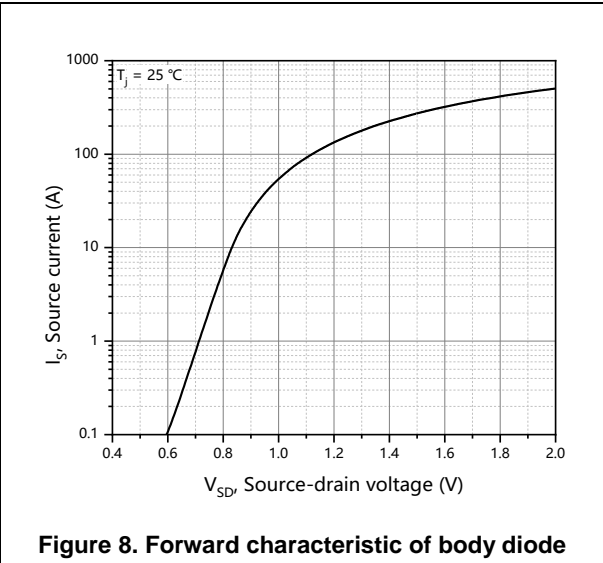
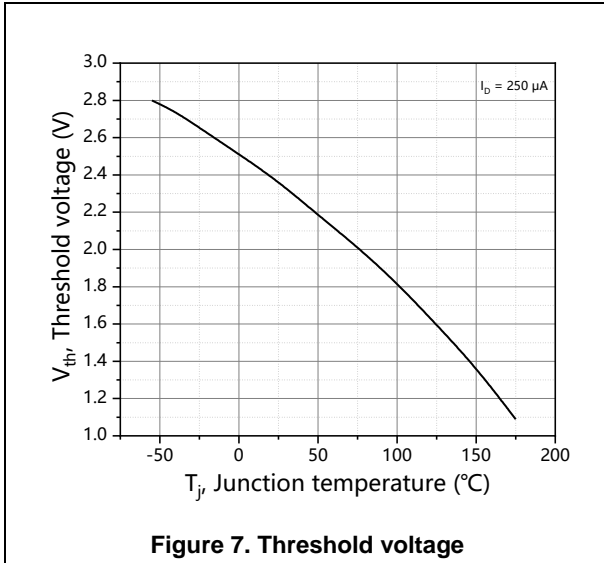

Figure 6. Drain-source on-state resistance



Test circuits and waveforms



Figure 1. Gate charge test circuit & waveform



Figure 2. Switching time test circuit & waveforms

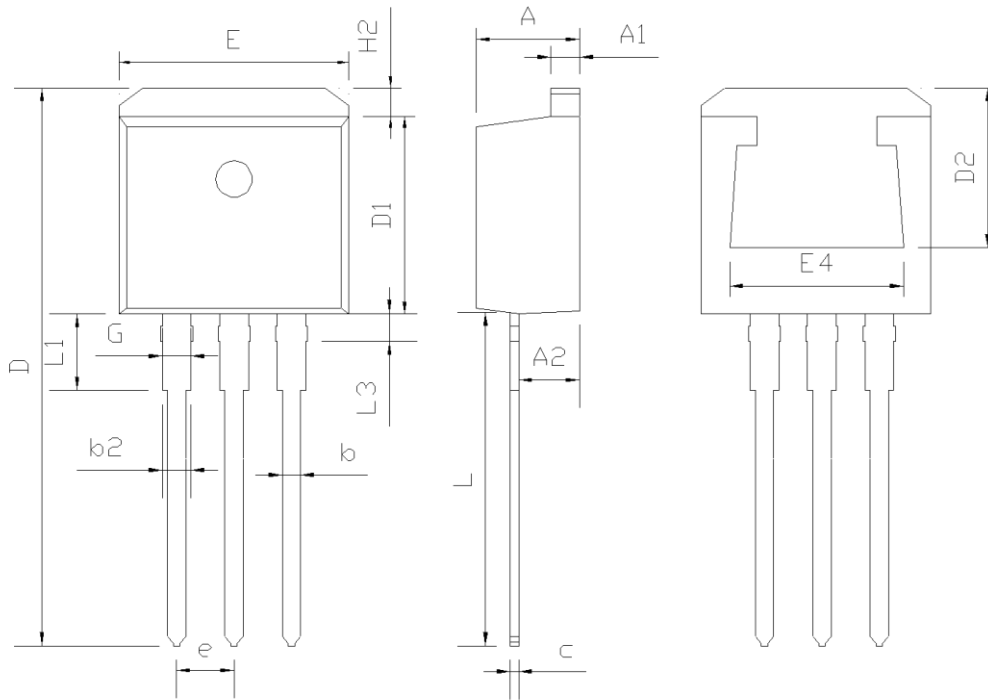

Figure 3. Unclamped inductive switching (UIS) test circuit & waveforms



Figure 4. Diode reverse recovery test circuit & waveforms

Package Information



Symbol	mm		
	Min	Nom	Max
A	4.37	4.57	4.77
A1	1.22	1.27	1.42
A2	2.49	2.69	2.89
b	0.71	0.81	0.96
b2	1.17	1.27	1.42
c	0.28	0.38	0.53
D	23.20	23.70	24.02
D1	8.50	8.70	8.90
D2	6.00	-	-
E	9.86	10.16	10.36
E4	7.06	-	-
e	2.54 BSC		
H2	-	-	1.50
L	13.33	13.73	14.13
L1	3.50	3.75	4.00
L3	1.28	1.43	1.58
G	1.25	1.35	1.50

Version : TO262-P package outline dimension

Ordering Information

Package Type	Units/ Tube	Tubes/ Inner Box	Units/ Inner Box	Inner Boxes/ Carton Box	Units/ Carton Box
TO262-P	50	20	1000	6	6000

Product Information

Product	Package	Pb Free	RoHS	Halogen Free
SFS15R20IF	TO262	yes	yes	yes

Legal Disclaimer

The information given in this document shall in no event be regarded as a guarantee of conditions or characteristics. With respect to any examples or hints given herein, any typical values stated herein and/or any information regarding the application of the device, Oriental Semiconductor hereby disclaims any and all warranties and liabilities of any kind, including without limitation, warranties of non-infringement of intellectual property rights of any third party.

For further information on technology, delivery terms and conditions and prices, please contact the Oriental Semiconductor sales representatives (www.orientalsemi.com).

© Oriental Semiconductor Co.,Ltd. All Rights Reserved /

Revision History

Version	Revision History	Date
V1.0	Initial release	2025-10-23