

General Description

The silicon carbide power MOSFET utilizes Oriental-Semi's advanced technology to achieve low on-resistance, low gate charge, low Qrr and excellent thermal performance by exploiting innovative properties of wide bandgap materials. It is engineered to minimize conduction loss and provide superior switching performance almost independent of temperature.

The silicon carbide power MOSFET provides high reliability and extremely high efficiency. It is targeted to improve application performance in frequency, energy efficiency, reliability, system size and weight reduction.

Features

- High blocking voltage with low on-resistance
- High-speed switching with low capacitances
- IGBT-compatible driving voltage (15V for turn-on)
- Fast intrinsic diode with low reverse recovery (Qrr)
- Temperature independent turn-off switching losses
- Halogen free, RoHS compliant

Applications

- On-board charger/PFC
- EV motor drive
- High voltage DC/DC converters
- Switch mode power supplies

Key Performance Parameters

Parameter	Value	Unit
V_{DS}	650	V
I_D , pulse	156	A
$R_{DS(ON)}$, typ @ $V_{GS}=18V$	45	m Ω
Q_g	46	nC

Marking Information

Product Name	Package	Marking
OSQ65R045TT2F	TOLL	OSQ65R045TT2

Package & Pin Information

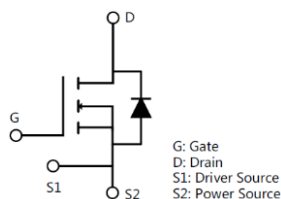

Absolute Maximum Ratings at $T_j=25^{\circ}\text{C}$ unless otherwise noted

Parameter	Symbol	Value	Unit
Drain-source voltage	V_{DS}	650	V
Gate-source voltage (max static)	V_{GS}	-8/+22	V
Gate-source voltage (recommended operating values)	V_{GS}	-4/+18	V
Continuous drain current ¹⁾ , $T_C=25^{\circ}\text{C}$	I_D	46	A
Continuous drain current ¹⁾ , $T_C=100^{\circ}\text{C}$		32	
Pulsed drain current ²⁾	$I_{D, pulse}$	156	A
Power dissipation ³⁾ , $T_C=25^{\circ}\text{C}$	P_D	187	W
Operation and storage temperature	T_{stg}, T_j	-55 to 175	$^{\circ}\text{C}$

Thermal Characteristics

Parameter	Symbol	Min.	Typ.	Max.	Unit
Thermal resistance, junction-case	$R_{\theta JC}$		0.61	0.80	$^{\circ}\text{C/W}$
Thermal resistance, junction-ambient	$R_{\theta JA}$			62	$^{\circ}\text{C/W}$

Electrical Characteristics at $T_j=25^{\circ}\text{C}$ unless otherwise specified

Parameter	Symbol	Min.	Typ.	Max.	Unit	Test condition
Drain-source breakdown voltage	BV_{DSS}	650			V	$V_{GS}=0\text{ V}, I_D=100\ \mu\text{A}$
Gate threshold voltage	$V_{GS(th)}$	2.3	2.8	3.6	V	$V_{DS}=V_{GS}, I_D=5\text{ mA}$
Drain-source on-state resistance	$R_{DS(ON)}$		45	60	m Ω	$V_{GS}=18\text{ V}, I_D=15\text{ A}$
			60			$V_{GS}=18\text{ V}, I_D=15\text{ A}, T_j=175^{\circ}\text{C}$
			60	79	m Ω	$V_{GS}=15\text{ V}, I_D=15\text{ A}$
			70			$V_{GS}=15\text{ V}, I_D=15\text{ A}, T_j=175^{\circ}\text{C}$
Transconductance	g_{fs}		9		S	$V_{DS} = 20\text{ V}, I_D = 15\text{ A}$
Gate-source leakage current	I_{GSS}			± 100	nA	$V_{GS}=-8\sim 22\text{ V}$
Drain-source leakage current	I_{DSS}			100	μA	$V_{DS}=650\text{ V}, V_{GS}=0\text{ V}$
				500	μA	$V_{DS}=650\text{ V}, V_{GS}=0\text{ V}, T_j=175^{\circ}\text{C}$
Gate resistance	R_G		2.3		Ω	$f=1\text{ MHz}, \text{Open drain}, V_{AC}=25\text{ mV}$

Dynamic Characteristics

Parameter	Symbol	Min.	Typ.	Max.	Unit	Test condition
Input capacitance	C_{iss}		1200		pF	$V_{GS}=0\text{ V}$, $V_{DS}=400\text{ V}$, $f=1\text{ MHz}$, $V_{AC}=25\text{ mV}$
Output capacitance	C_{oss}		113		pF	
Reverse transfer capacitance	C_{rss}		4.3		pF	
C_{oss} stored energy	E_{oss}		10.6		μJ	
Turn-on delay time	$t_{d(on)}$		9.6		ns	$V_{GS}=-4/18\text{ V}$, $V_{DS}=400\text{ V}$, $R_G=5\ \Omega$, $I_D=15\text{ A}$, $L=120\ \mu\text{H}$, $T_j=25\text{ }^\circ\text{C}$
Rise time	t_r		8.5		ns	
Turn-off delay time	$t_{d(off)}$		17.4		ns	
Fall time	t_f		8.0		ns	
Turn-on switching energy	E_{on}		27		μJ	
Turn-off switching energy	E_{off}		10.8		μJ	
Turn-on switching energy	E_{on}		24.6		μJ	$V_{GS}=-4/18\text{ V}$, $V_{DS}=400\text{ V}$, $R_G=5\ \Omega$, $I_D=15\text{ A}$, $L=120\ \mu\text{H}$, $T_j=175\text{ }^\circ\text{C}$
Turn-off switching energy	E_{off}		11		μJ	

Gate Charge Characteristics

Parameter	Symbol	Min.	Typ.	Max.	Unit	Test condition
Total gate charge	Q_g		46		nC	$V_{GS}=-4/18\text{ V}$, $V_{DS}=400\text{ V}$, $I_D=15\text{ A}$
Gate-source charge	Q_{gs}		15.4		nC	
Gate-drain charge	Q_{gd}		9.5		nC	

Body Diode Characteristics

Parameter	Symbol	Min.	Typ.	Max.	Unit	Test condition
Diode forward voltage	V_{SD}		4.4		V	$I_S=15\text{ A}$, $V_{GS}=-4\text{ V}$, $T_J=25\text{ °C}$
			3.9		V	$I_S=15\text{ A}$, $V_{GS}=-4\text{ V}$, $T_J=175\text{ °C}$
Continuous diode forward current	I_S		46		A	$V_{GS}=-4\text{ V}$, $T_J=25\text{ °C}$
Reverse recovery time	t_{rr}		12.5		ns	$V_{GS}=-4\text{ V}$, $V_R=400\text{ V}$,
Reverse recovery charge	Q_{rr}		122		nC	$I_S=15\text{ A}$,
Peak reverse recovery current	I_{rrm}		17.3		A	$di/dt=3000\text{ A}/\mu\text{s}$, $T_J=25\text{ °C}$
Reverse recovery time	t_{rr}		18		ns	$V_{GS}=-4\text{ V}$, $V_R=400\text{ V}$,
Reverse recovery charge	Q_{rr}		85		nC	$I_S=15\text{ A}$,
Peak reverse recovery current	I_{rrm}		8.2		A	$di/dt=1000\text{ A}/\mu\text{s}$, $T_J=175\text{ °C}$

Note

- 1) Calculated continuous current based on maximum allowable junction temperature.
- 2) Repetitive rating; pulse width limited by max. junction temperature.
- 3) P_d is based on max. junction temperature, using junction-case thermal resistance.

Electrical Characteristics Diagrams

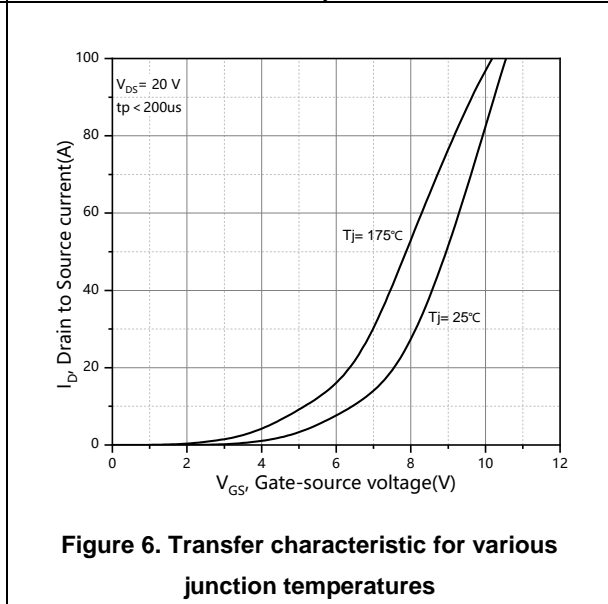
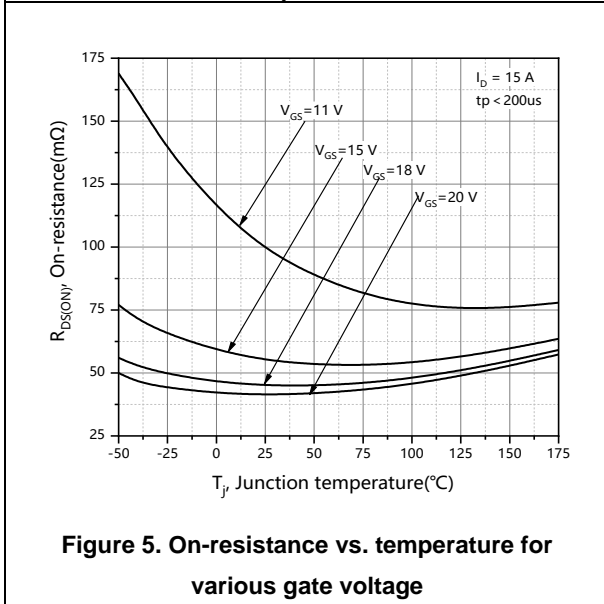
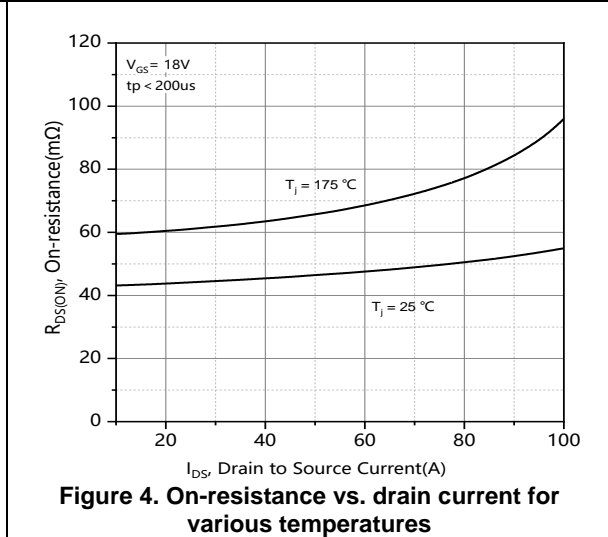
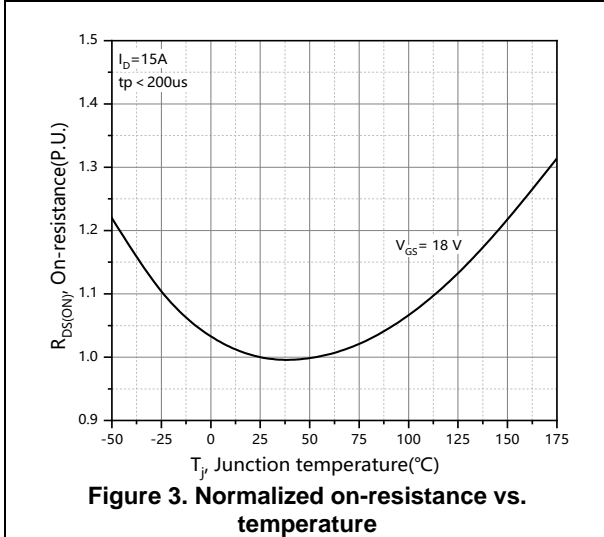
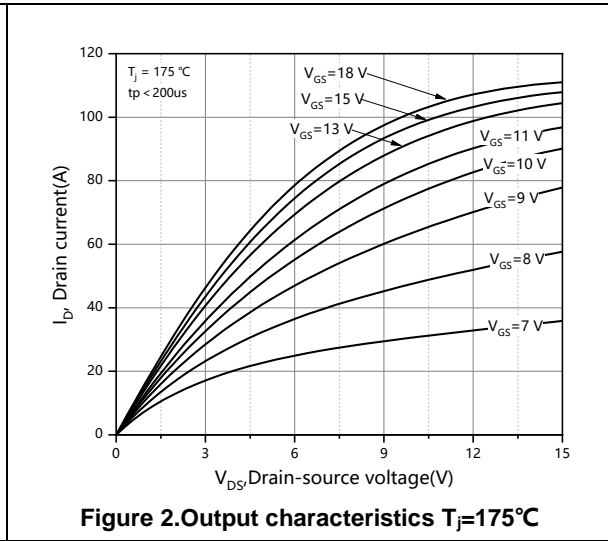
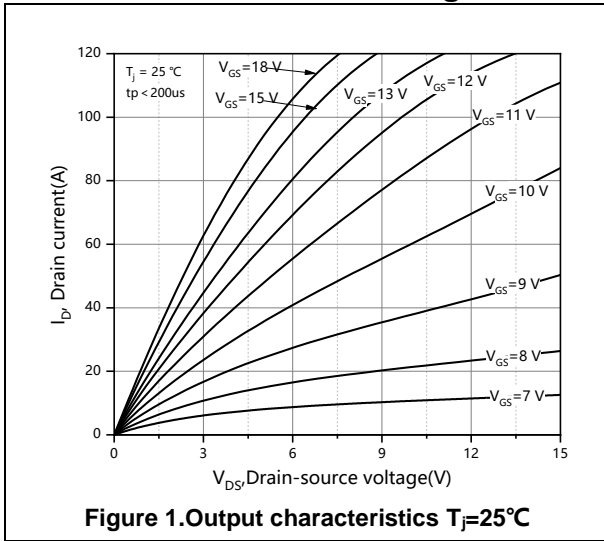

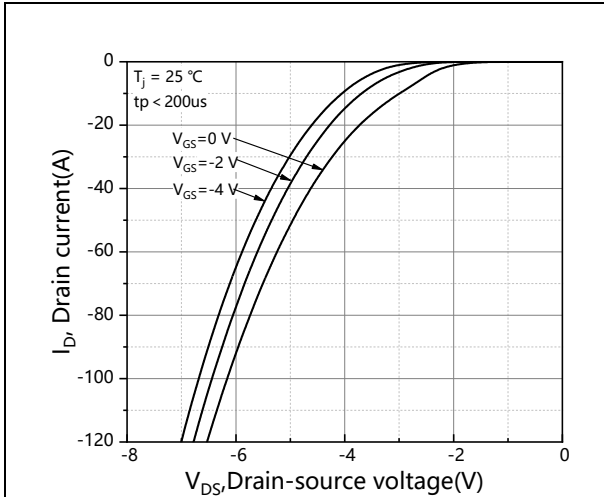

Figure 7. Body diode characteristic at $T_j = 25\text{ }^\circ\text{C}$

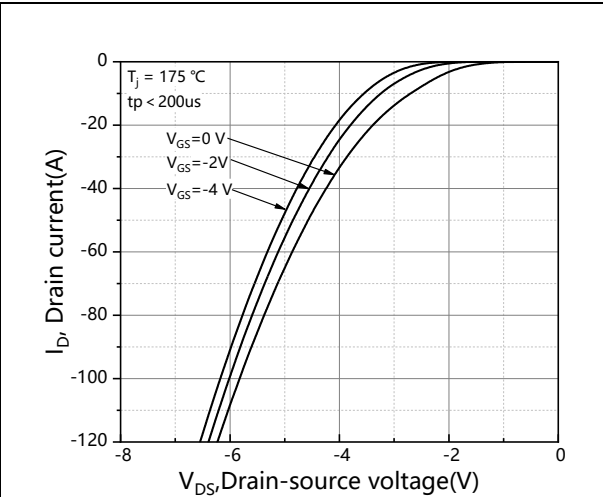

Figure 8. Body diode characteristic at $T_j = 175\text{ }^\circ\text{C}$

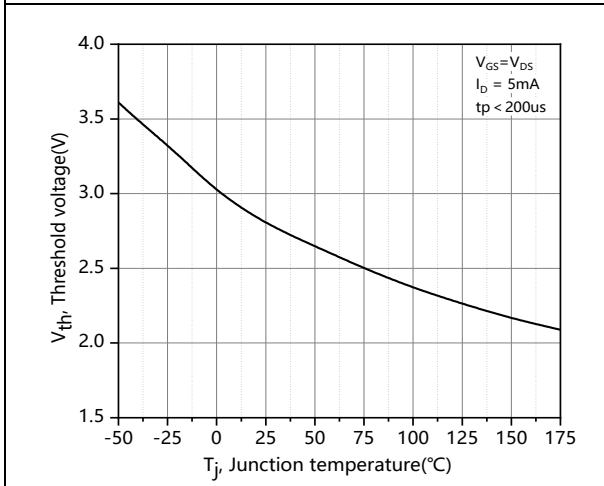

Figure 9. Threshold voltage vs. temperature

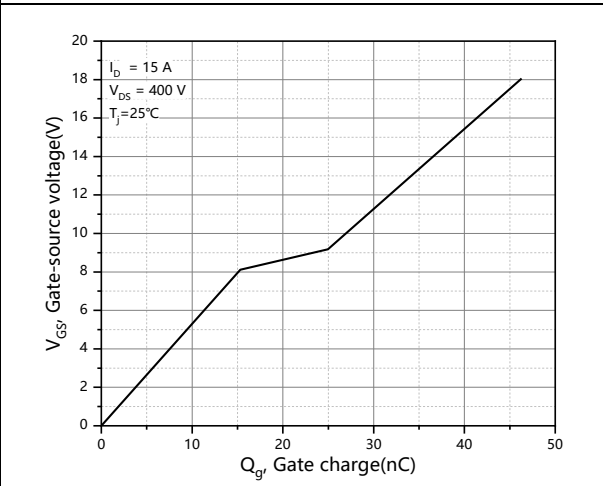

Figure 10. Gate charge characteristic

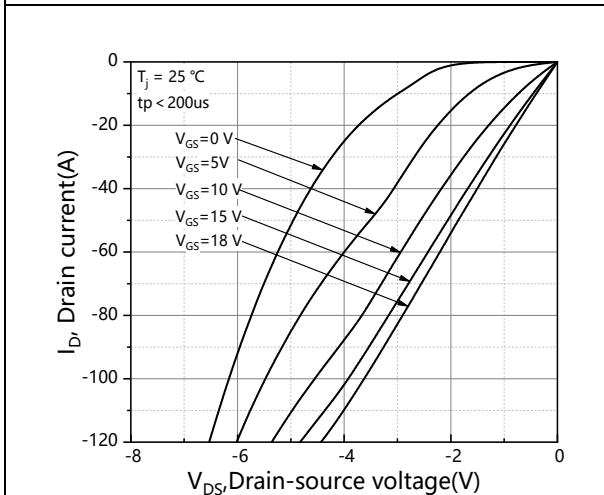

Figure 11. 3rd quadrant characteristic at $T_j = 25\text{ }^\circ\text{C}$

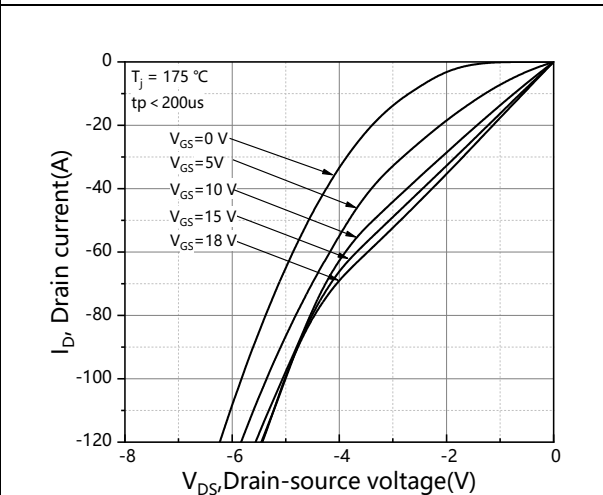

Figure 12. 3rd quadrant characteristic at $T_j = 175\text{ }^\circ\text{C}$

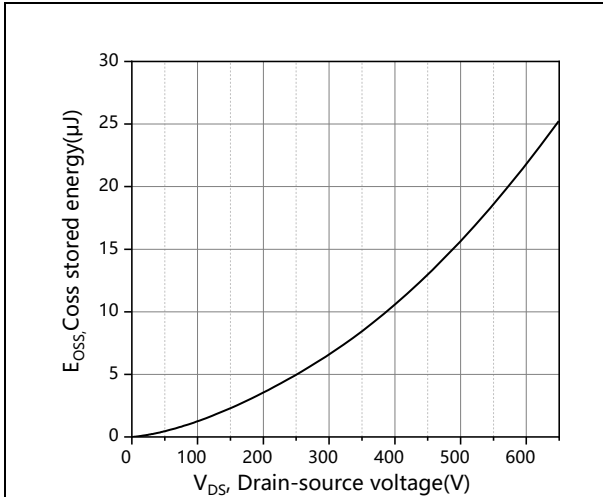

Figure 13. Output capacitor stored energy

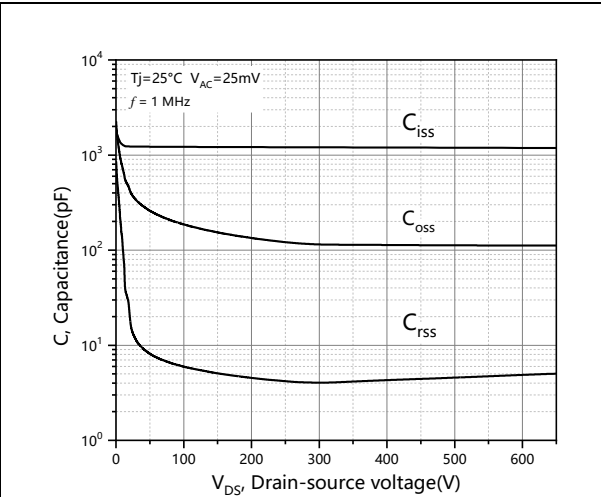

Figure 14. Capacitances vs. drain-source voltage

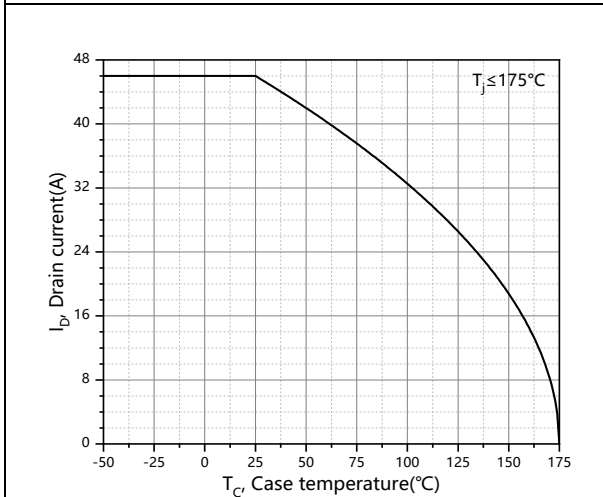

Figure 15. Continuous drain current derating vs. case temperature

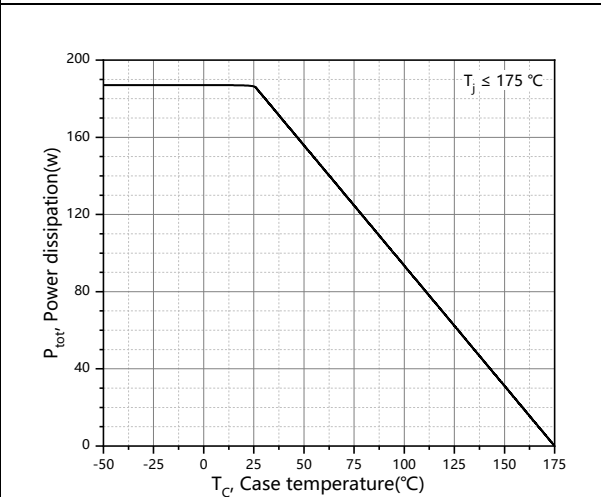

Figure 16. Maximum power dissipation derating vs. case temperature

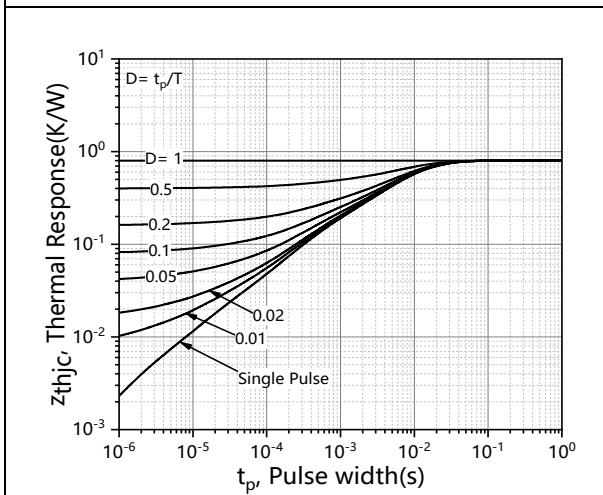

Figure 17. Transient thermal impedance (junction - case)

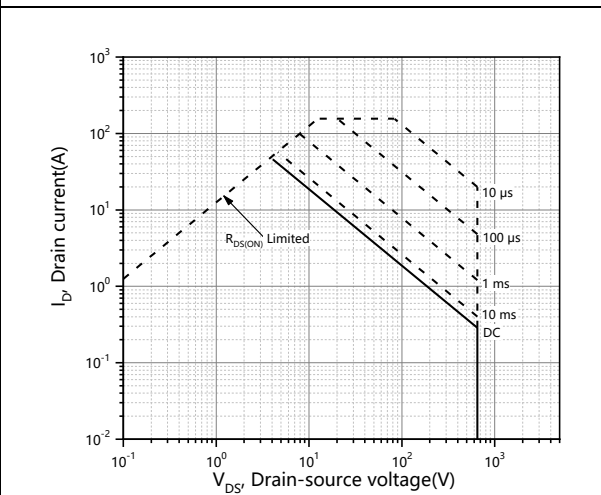
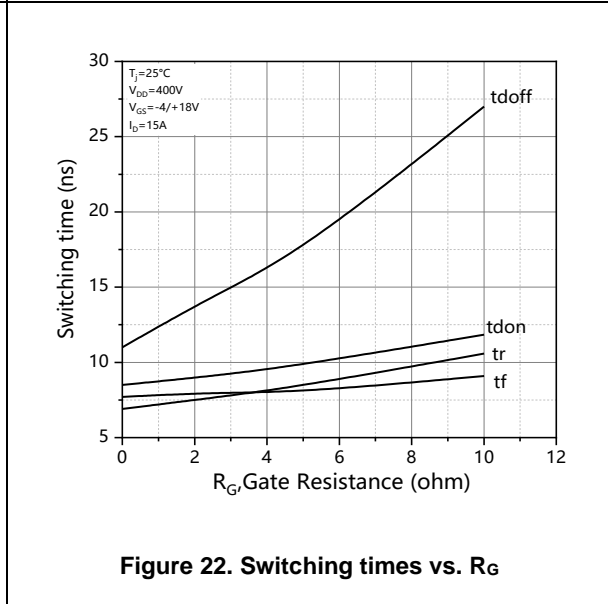
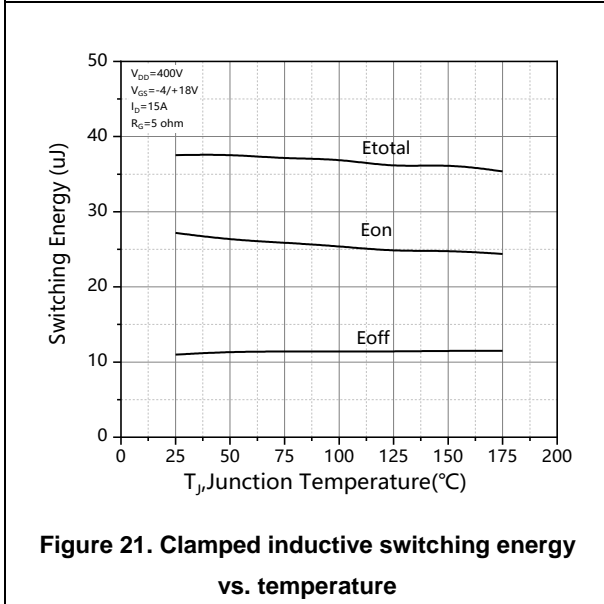
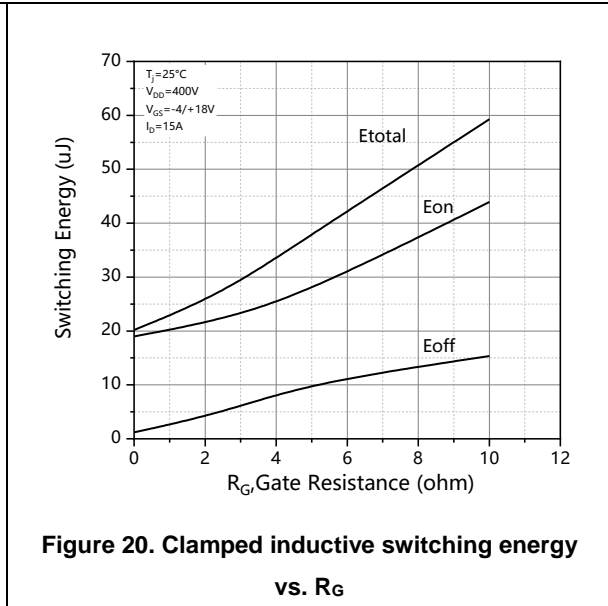
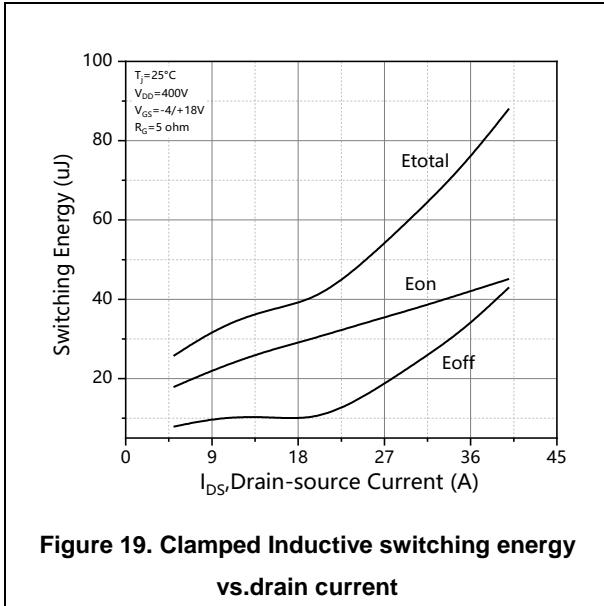
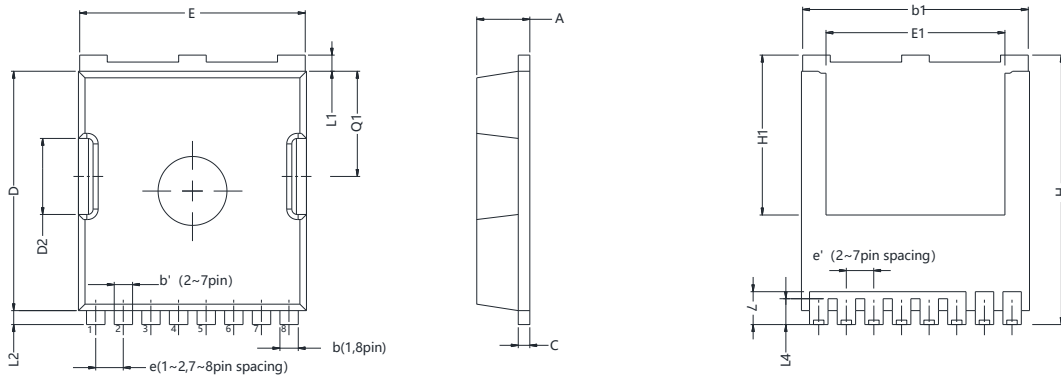

Figure 18. Safe operating area



Package Information



Symbol	mm		
	Min	Nom	Max
A	2.15	2.30	2.45
b	0.75	0.75	0.85
b'	0.70	0.70	0.80
b1	9.65	9.80	9.95
C	0.45	0.50	0.60
D	10.18	10.38	10.58
D2	3.15	3.30	3.45
E	9.70	9.90	10.10
E1	7.95	8.10	8.25
e	BSC 1.225		
e'	BSC 1.20		
Q1	4.40	4.55	4.70
H	11.48	11.68	11.88
H1	6.80	6.95	7.10
L	1.60	1.80	2.00
L1	0.50	0.70	0.90
L2	0.48	0.60	0.72
L4	1.00	1.15	1.30

Version 1: TOLL-P-package outline dimension

Ordering Information

Package Type	Units/ Reel	Reels/ Inner Box	Units/ Inner Box	Inner Boxes/ Carton Box	Units/ Carton Box
TOLL-P	1200	1	1200	5	6000

Product Information

Product	Package	Pb Free	RoHS	Halogen Free
OSQ65R045TT2F	TOLL	yes	yes	yes

Legal Disclaimer

The information given in this document shall in no event be regarded as a guarantee of conditions or characteristics. With respect to any examples or hints given herein, any typical values stated herein and/or any information regarding the application of the device, Oriental Semiconductor hereby disclaims any and all warranties and liabilities of any kind, including without limitation, warranties of non-infringement of intellectual property rights of any third party.

For further information on technology, delivery terms and conditions and prices, please contact the Oriental Semiconductor sales representatives (www.orientalsemi.com).

© Oriental Semiconductor Co.,Ltd. All Rights Reserved 